



WEDA EASTERN CHAPTER MEETING

GLDD'S ATB ELLIS ISLAND & TUG D.B. MACKIE

Ellis Island length 433 ft. Breadth 92 ft
 Installed power 11,300 hp

D. B. Mackie length 158 ft. Breadth 52 ft.
 Installed power 17,300hp

15,000 cubic yard hopper capacity
(largest hopper dredge in US Market)

Eastern Shipbuilding Group
Panama City Florida

October 2017

GREAT LAKES HOPPER DREDGE BEGINNINGS

3500 cy Hopper Dredge 'Michigan'



Lincoln Park Reclamation in Chicago in 1931

Placing Sand Filling in Lincoln Park Extension.
For Commissioners of Lincoln Park.
Great Lakes Dredge & Dock Company.
Photo Chicago Arch. Photo. Co.,
July 29th, 1931. Contract 15698. R-3237.

MONTROSE AVENUE CHICAGO 1931

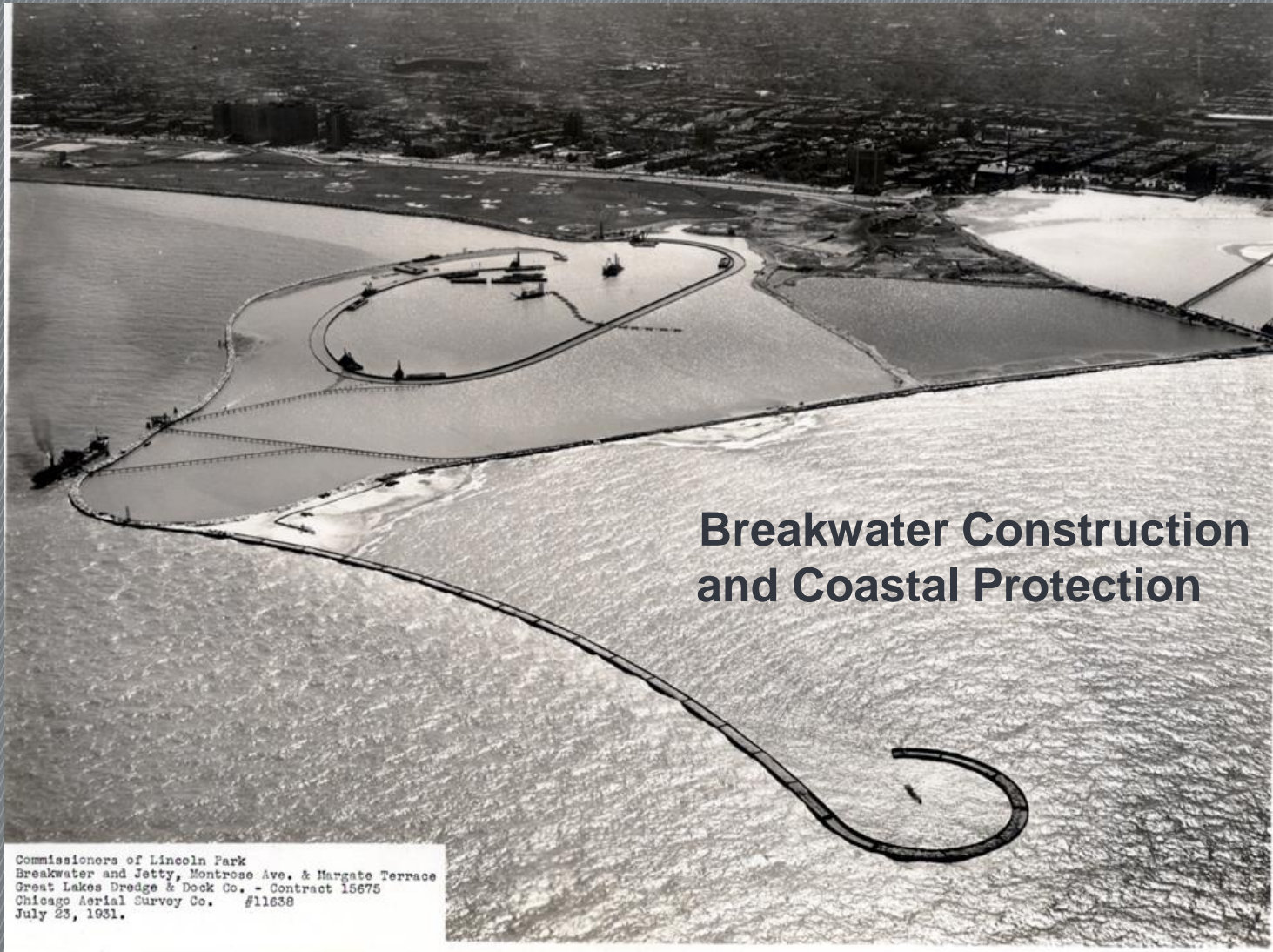

Breakwater Construction and Coastal Protection

Commissioners of Lincoln Park
Breakwater and Jetty, Montrose Ave. & Margate Terrace
Great Lakes Dredge & Dock Co. - Contract 15675
Chicago Aerial Survey Co. #11638
July 23, 1931.

MANHATTAN ISLAND 1ST SPLIT HULL HOPPER DREDGE



GREAT LAKES HOPPER DREDGE BEGINNINGS



GREAT LAKES HOPPER FLEET IN 2017



WHAT IS AN ARTICULATED TUG & BARGE?



ARTICULATED MOTION

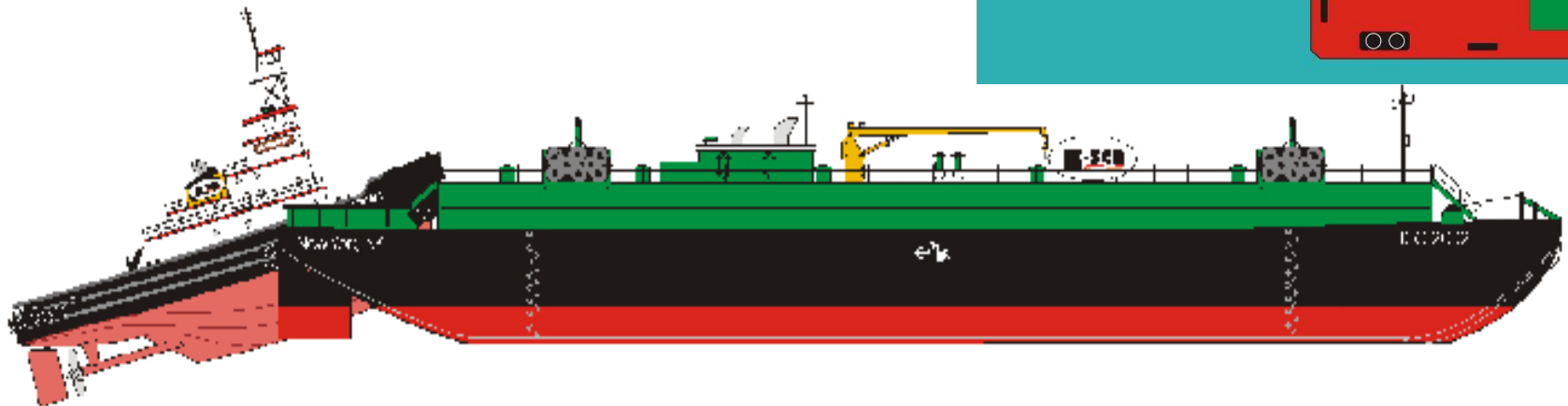
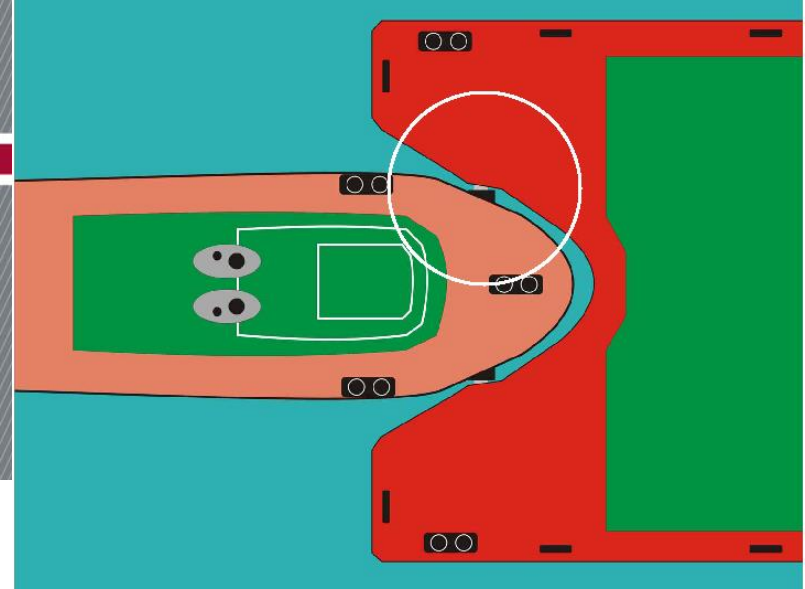

Designed to operate nominally at 15 degrees

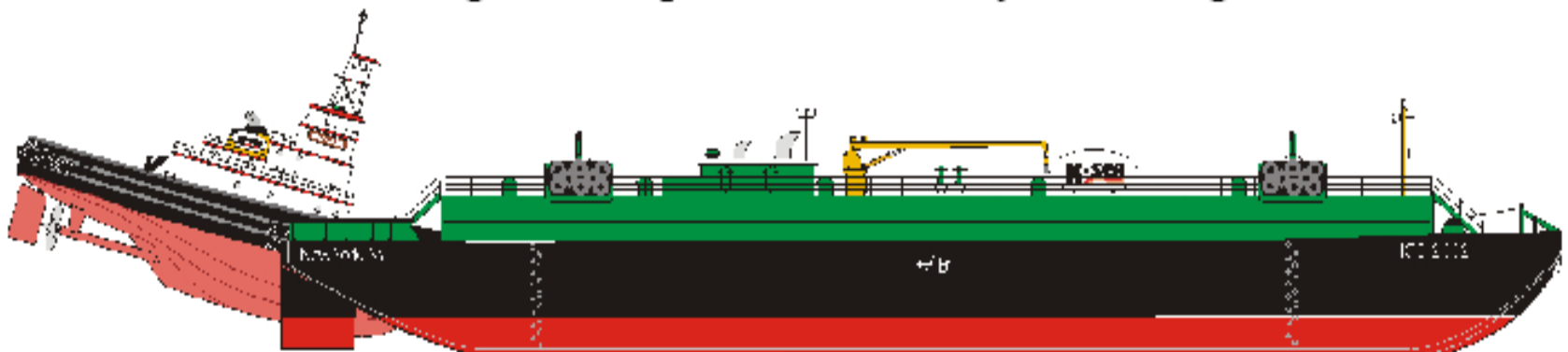

PIN CONNECTION

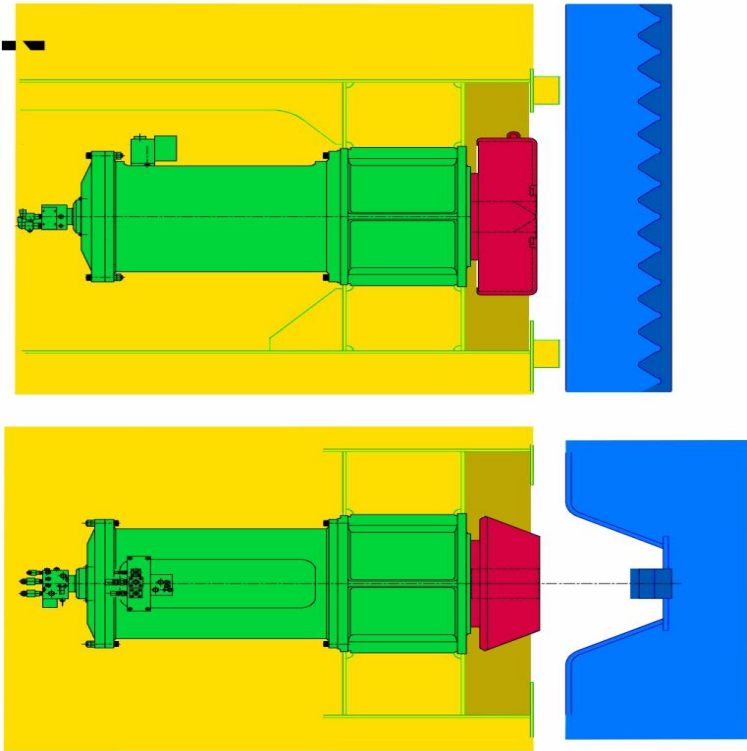

AN ATB IN DREDGING SERVICE???

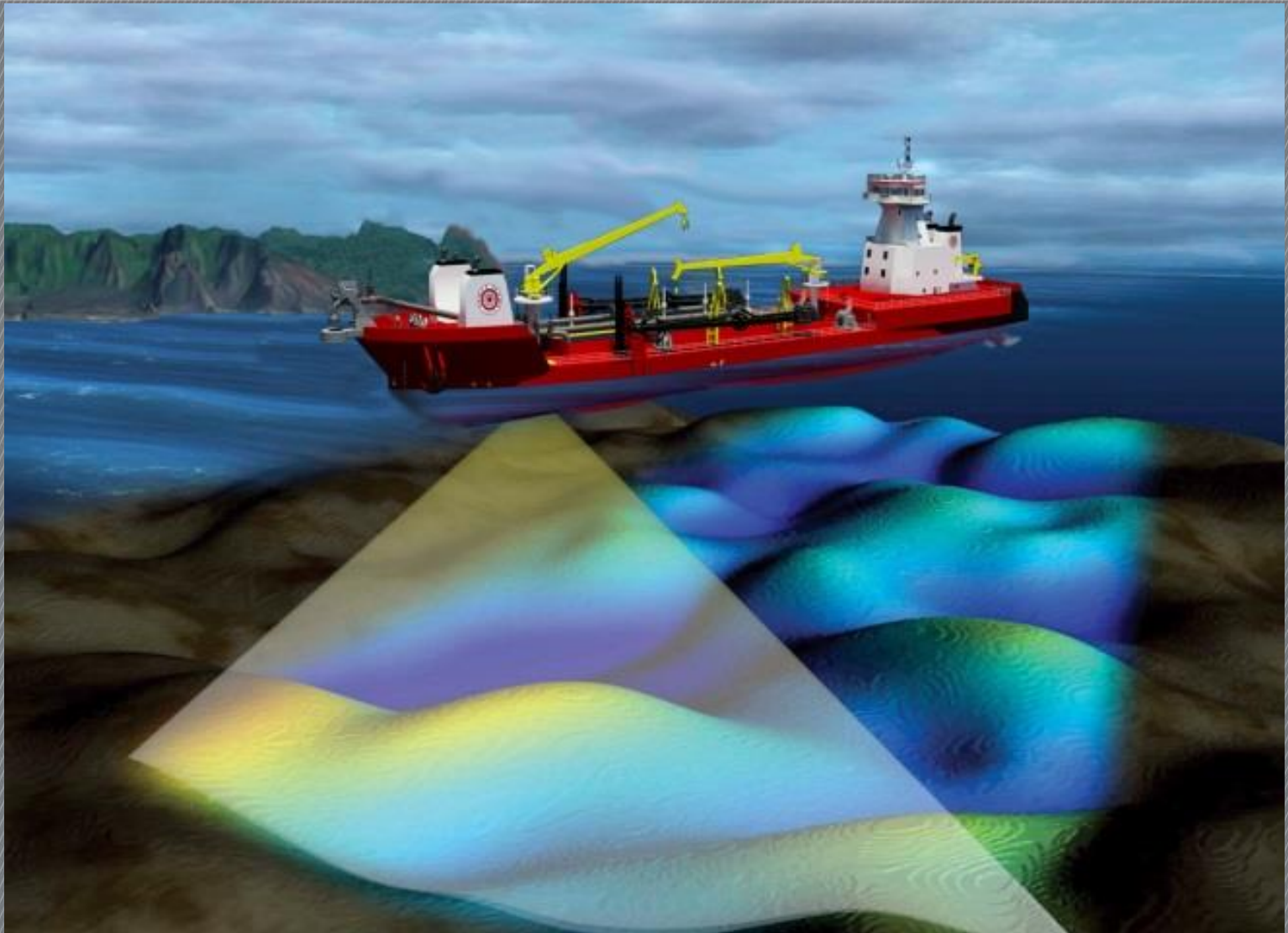

CHALLENGES FOR AN ATB IN DREDGING SERVICE

Dual Mode - Connect and disconnect - typically done while in port, in relatively calm waters.

In dredging by contrast, the tug and barge need to stay connected at all times, but the barge draft needs to be able to change as the barge is loaded or unloaded, and all of the foregoing needs to take place in up to moderate seas

- ❑ Can the ATB connection handle offshore wave conditions during loading and unloading
- ❑ ATBs typically 1 to 1.5kt slower speed than a similar sized ship. Can this be overcome?
- ❑ Can the ATB maneuver as easily as a ship?
- ❑ Will the longer length of the ATB compared to a ship prevent its use in certain channels?

SOME ATB ADVANTAGESb

- ✓ Cargo capacity - The cargo capacity of a hopper dredge is based on the vessel's displacement and its lightship weight which includes propulsion engines, generators, accommodations structure, fuel and other ship installations. This weight deducts from the cargo carrying capacity of the dredge.

In an ATB hopper dredge, these components and their associated weight are built into the tug and therefore do not deduct from the cargo carrying capacity of the barge. The tug's draft remains constant as the barge increases its load and draft.

- ✓ The manning requirements on this size tug typically result in a crew of 7-10 personnel. The license requirements are lower, i.e. tug license not ship license
- ✓ The manning requirements on the barge are typically zero, since the barge is considered unmanned; the owner crews to meet his *operational requirement*, not an imposed *regulatory requirement*.
- ✓ Today's trend in the U. S. Coastwise-Qualified (Jones Act) trade is to build an ATB instead of a ship for any route where the transit distance is short enough for the positive construction and operating cost economies to offset the negative cycle economies of the somewhat smaller size ATB.

GREAT LAKES' OBJECTIVES

- The dredge that will carry our Hopper Division to the next generation; the next step in the transition from a fleet of nearly identical dredges to a fleet consisting of different dredges for different purposes – each the low cost producer in its target market
- Meet future market needs with increased O & M demand and funding due to HMTF, Coastal Protection, Gulf Coast Restoration, and the latest channel deepening (Capital Dredging) cycle
- Improve operating margins
- Compete in non-traditional hopper markets
- Make otherwise marginal projects possible due to reduced cost to owner
- Ship-like performance and reliability while retaining the advantages of the ATB

OVERCOMING THE CHALLENGES – HULL FORM OPTIMIZATION

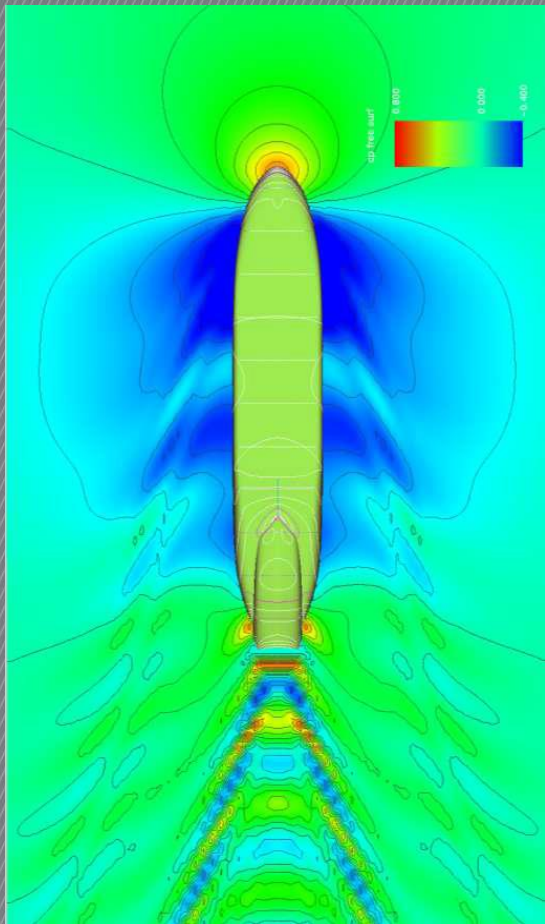

GET THE BOW RIGHT

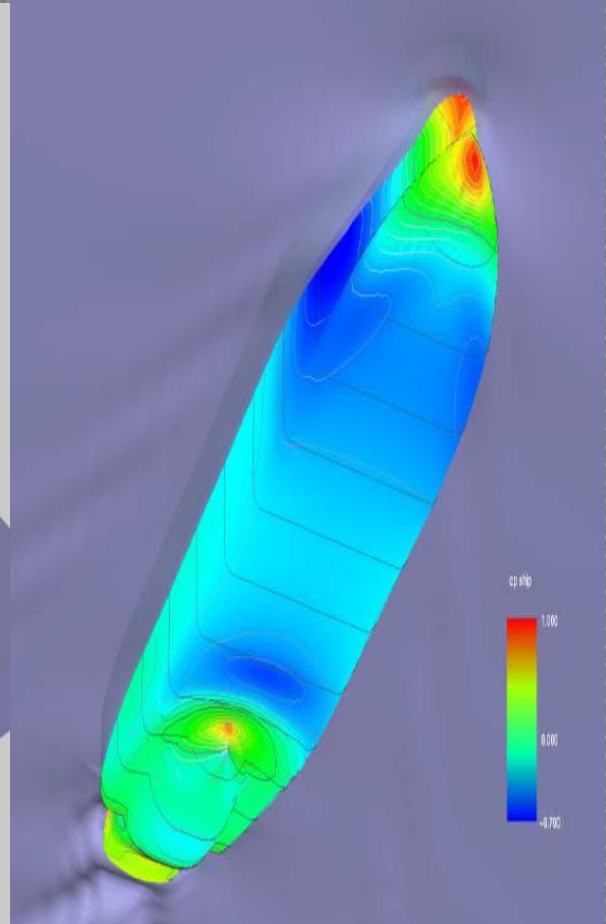
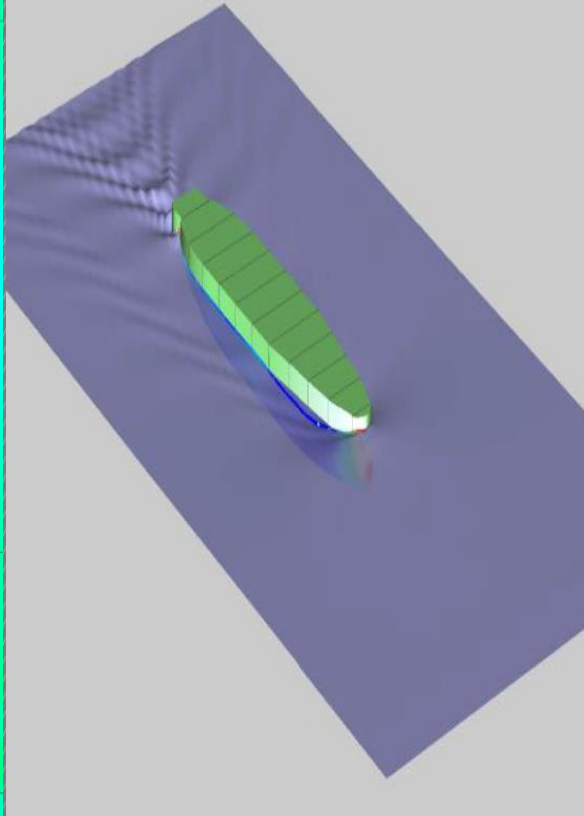

Great Lakes hull design, optimized using
Computational Fluid Dynamics (CFD)

TANK TESTS OF LIBERTY VS ELLIS ISLAND



The Liberty with the bulb requires 5,600 kW (7,500 HP) to achieve 13.5 kts in deep water,



The ATB with bulb requires 8,200 kW (11,000 HP) to achieve 13.5 kts in shallow water

More than 2x the capacity of the Liberty Island, same speed, 1.5x power, less wake

GETTING THE PROPELLER FLOW RIGHT

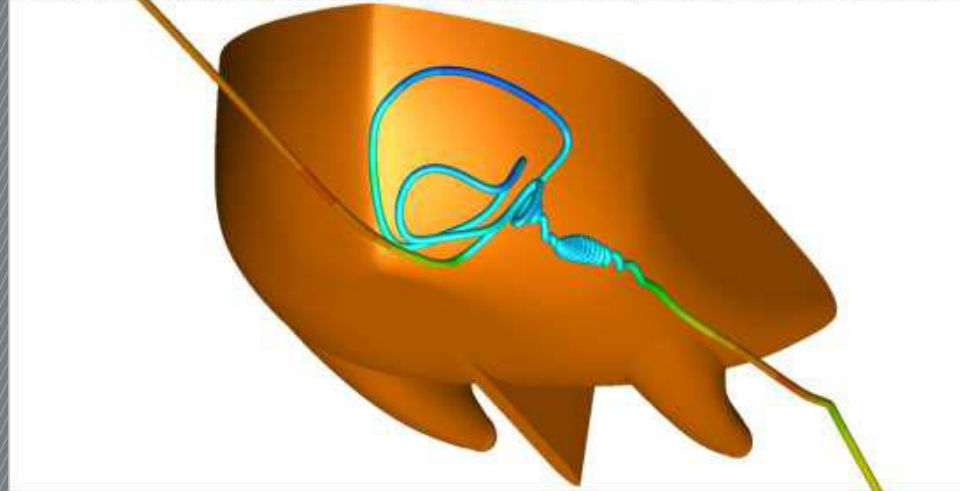
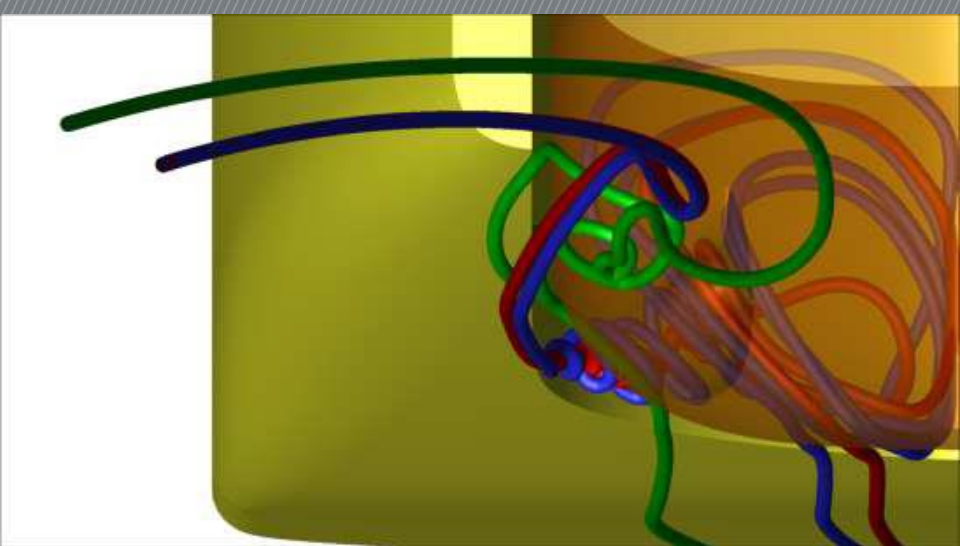
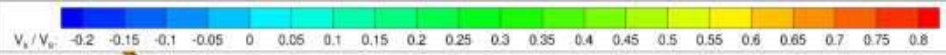
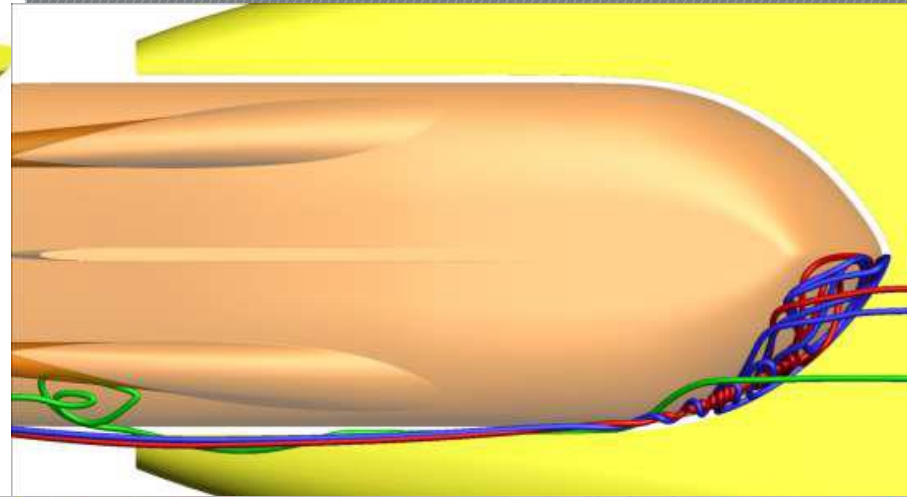
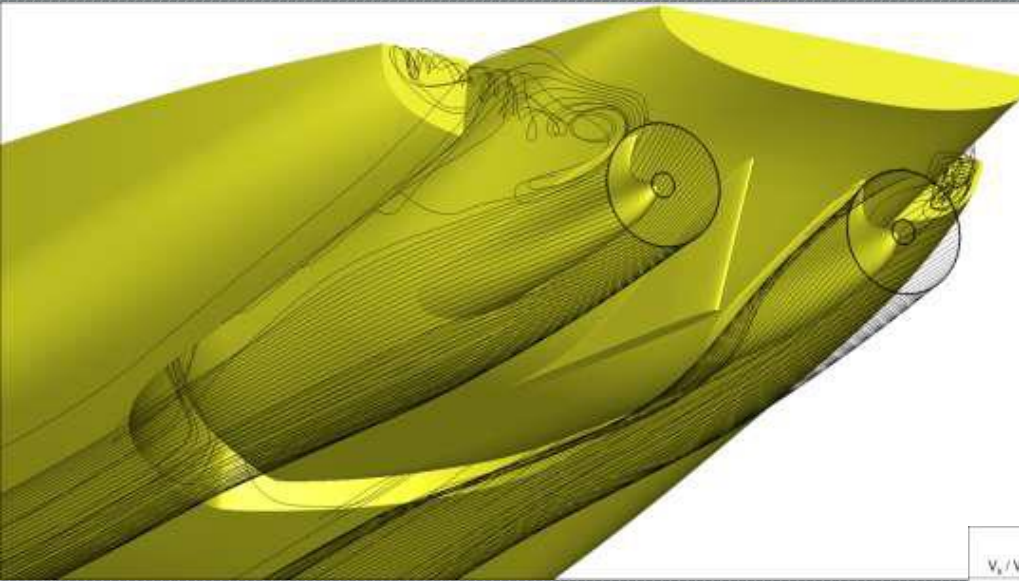

TUG MODEL TESTS

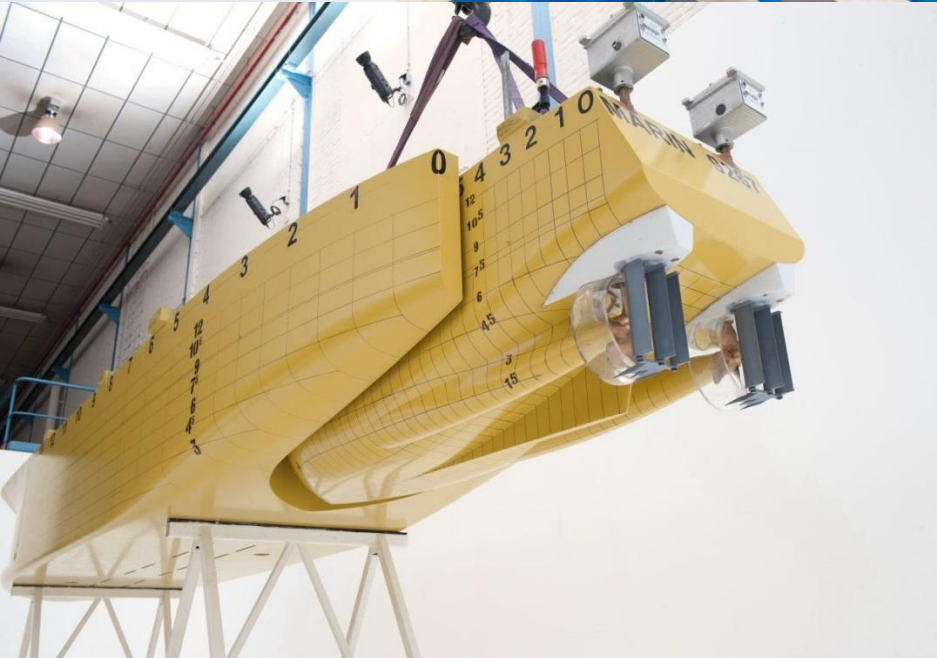
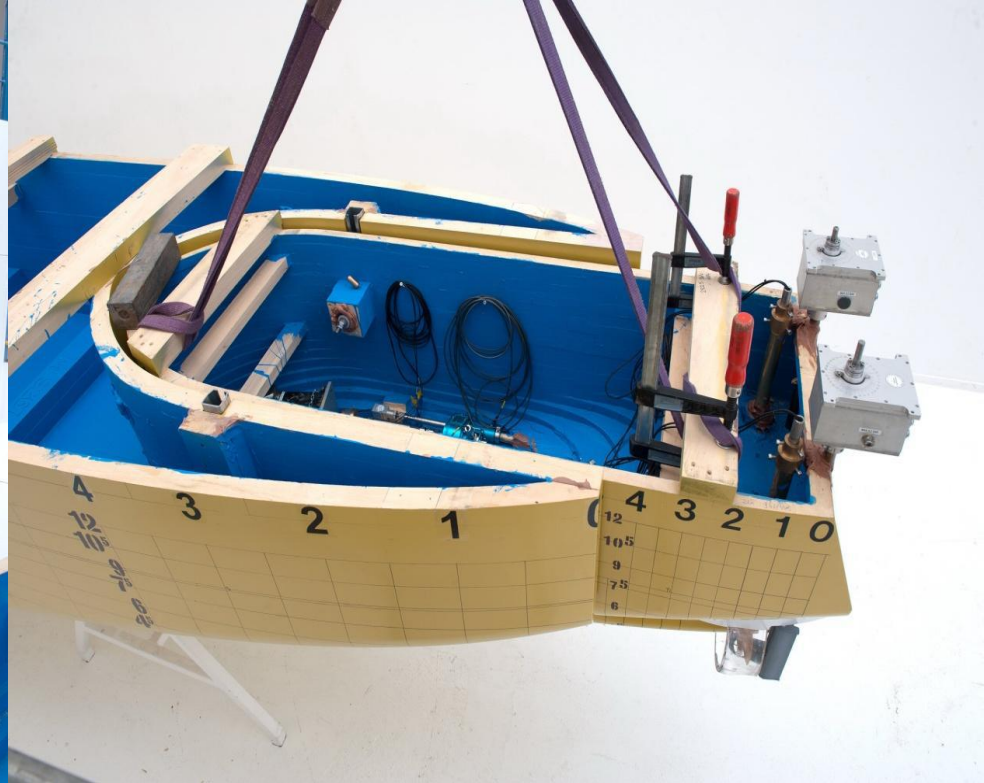
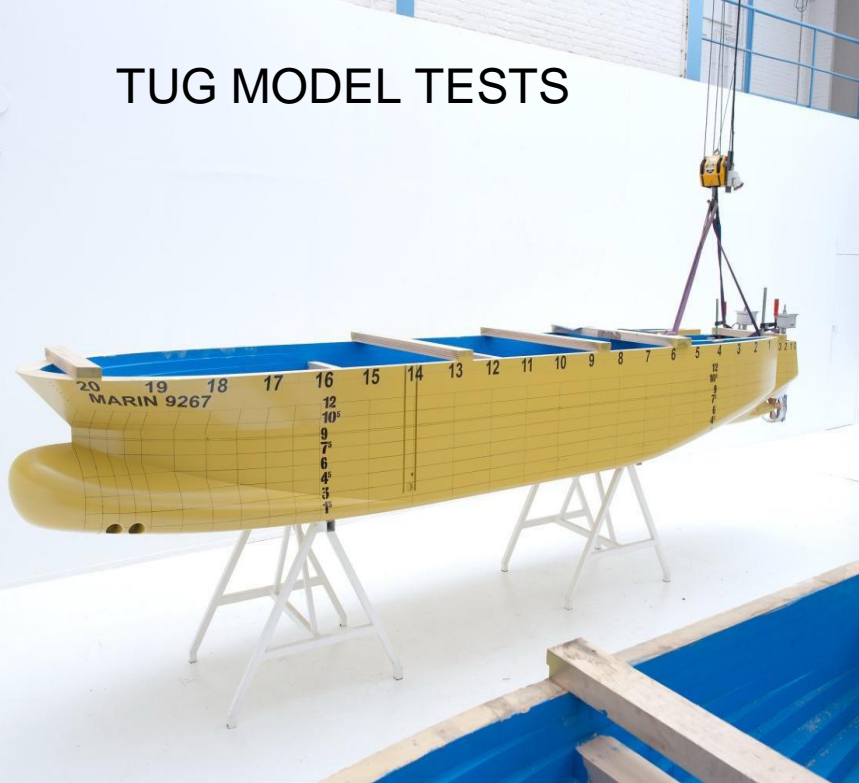

Steel Cutting 14 September 2014

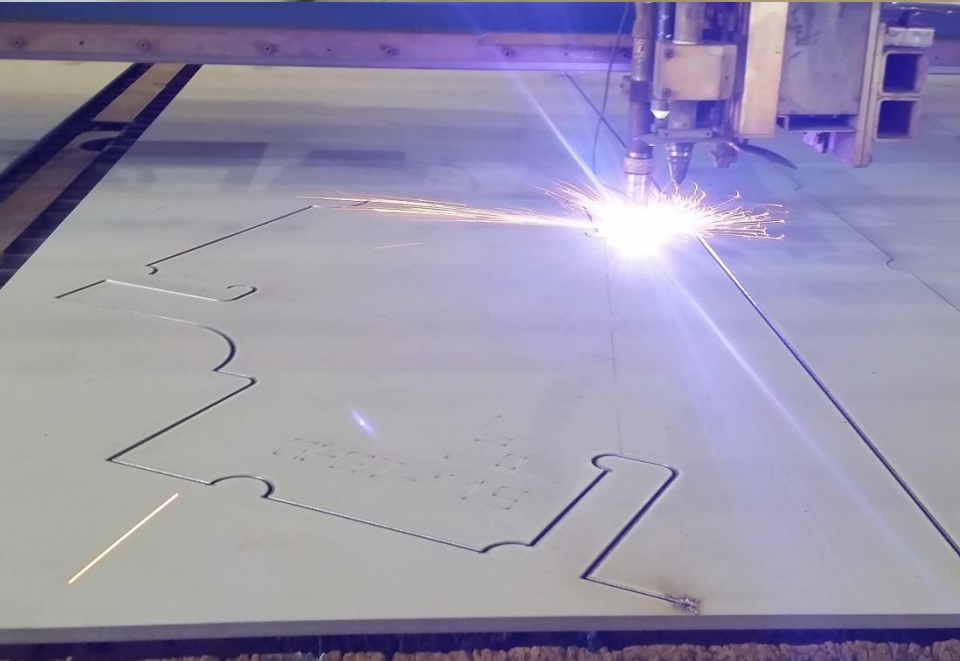

Tug Units

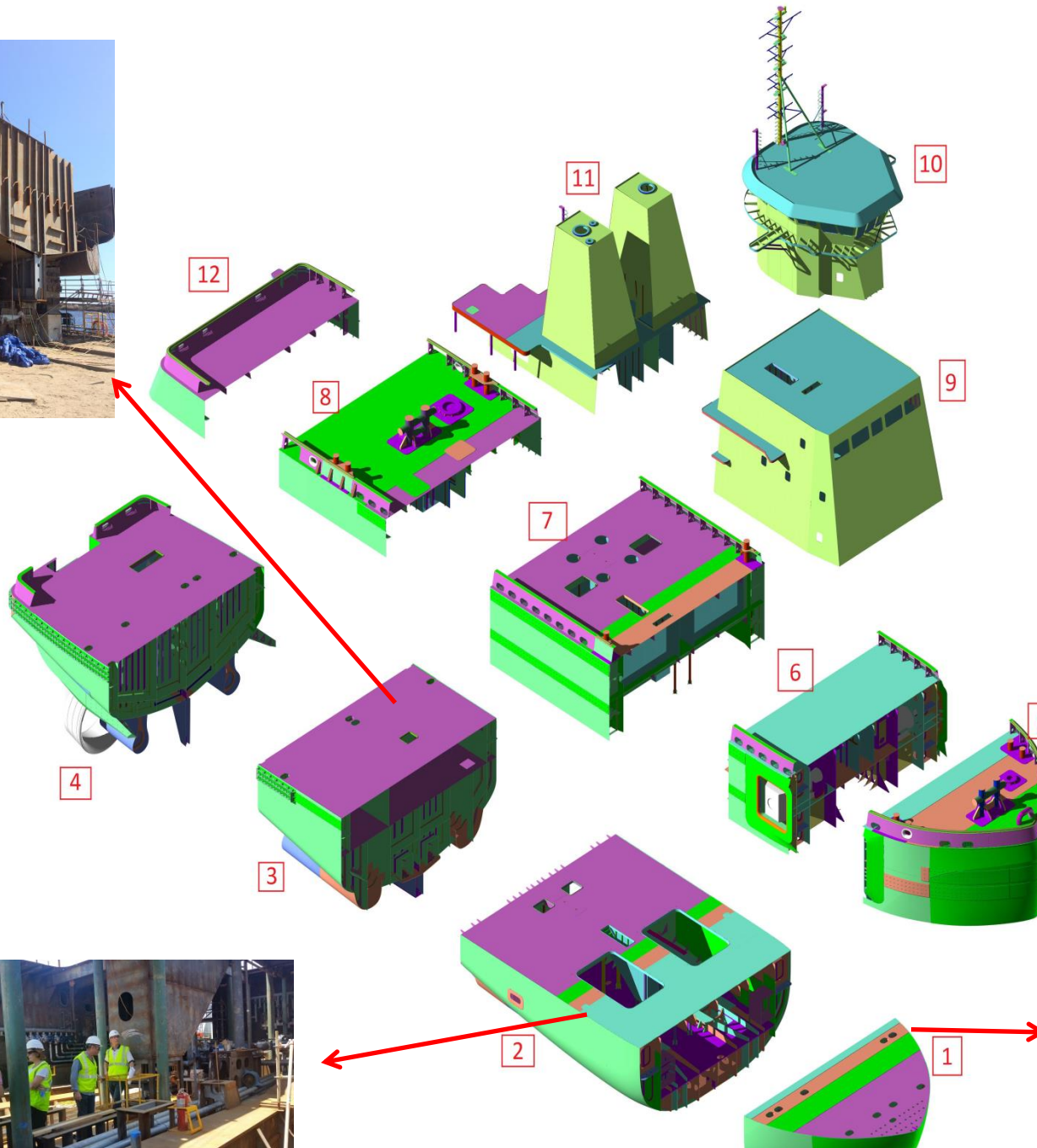

Tug *Douglas B. Mackie* 3D Model

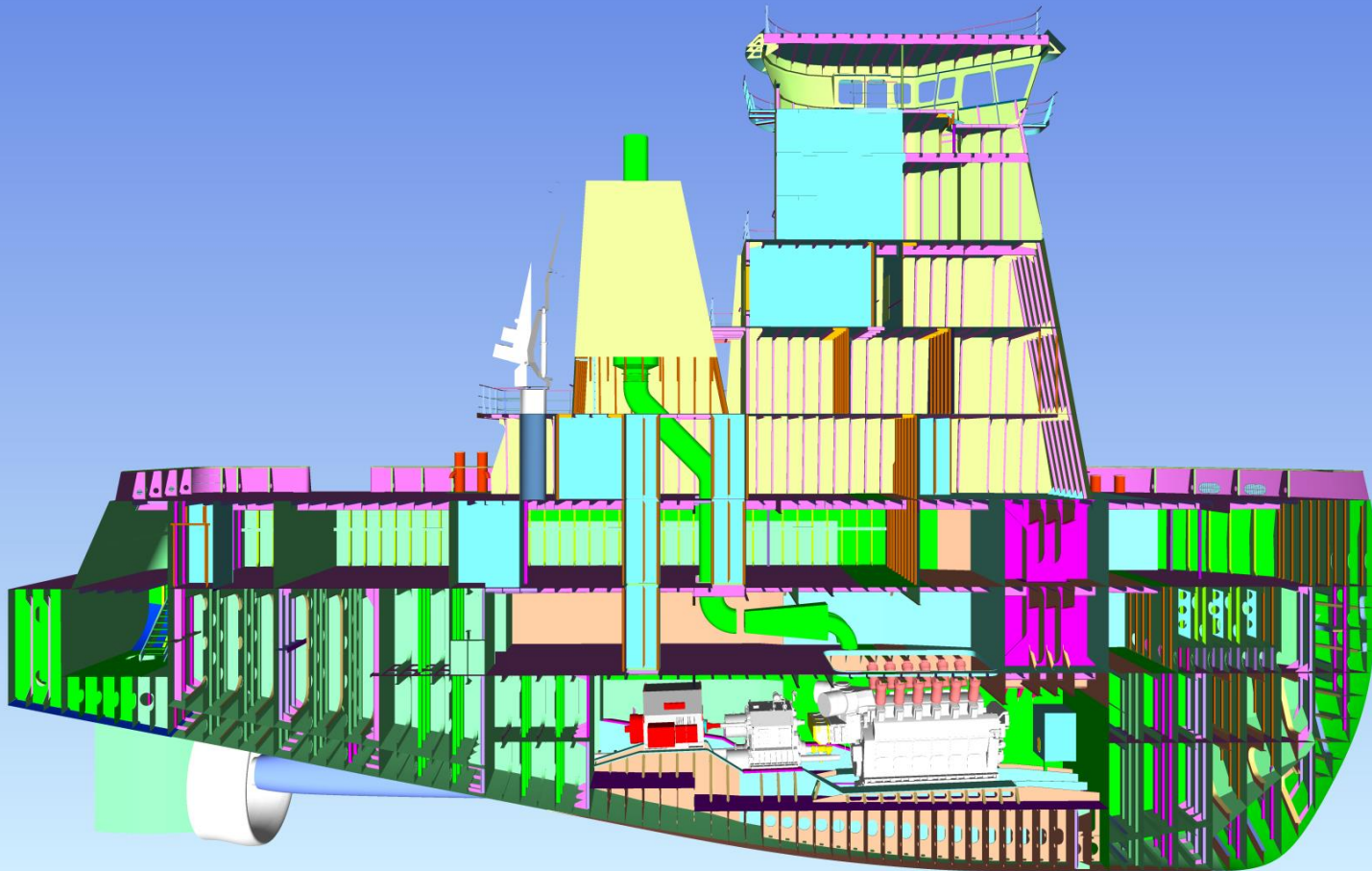

Final Deck Unit Installation



Main Engine Installation



Kort Nozzles



TUG TAISAI PIN CONNECTION

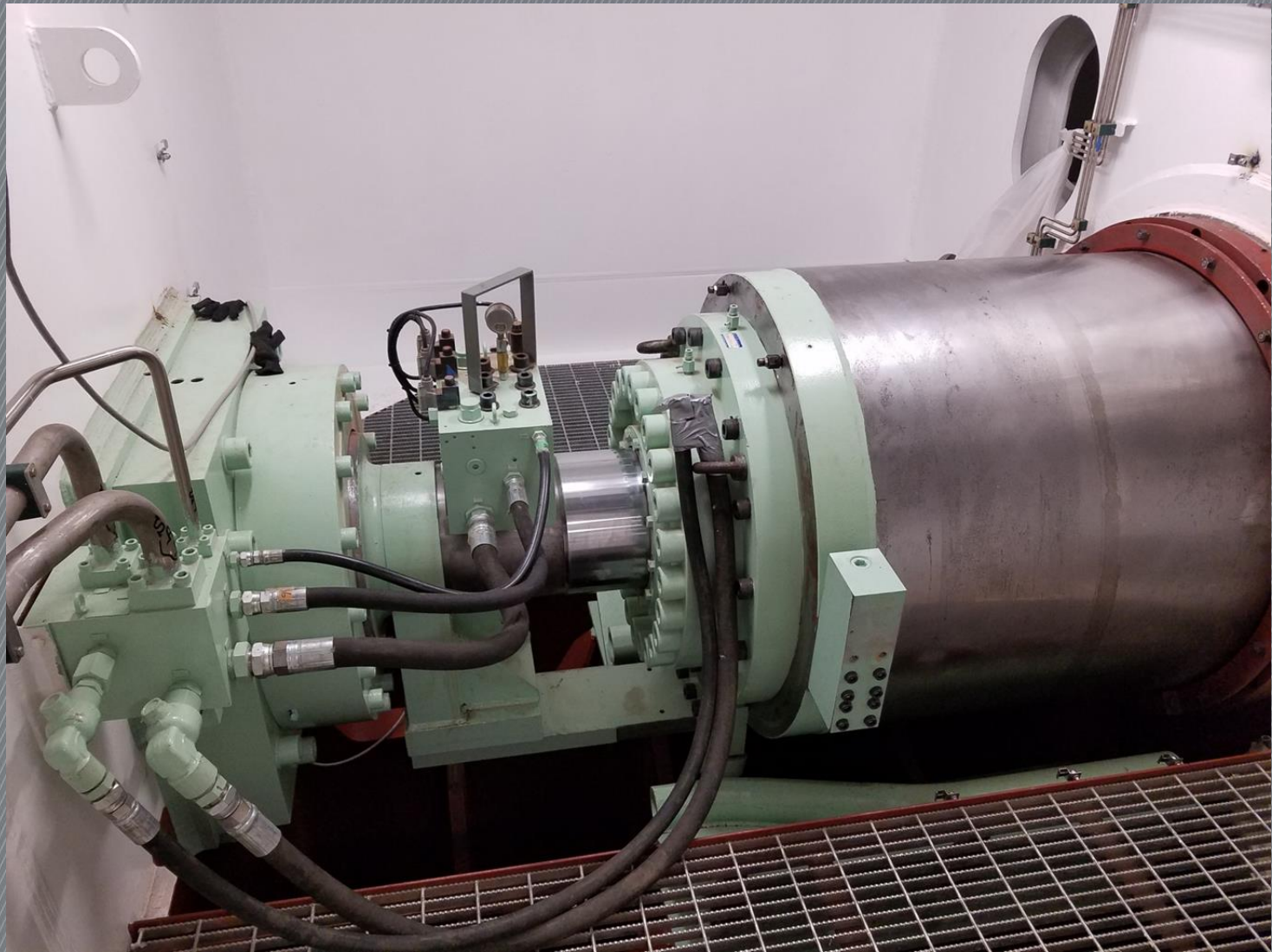

ARTICOUPLE CONNECTION



MAK 7,500 Hp Tug Main Engine



Tug Shaft Generator



TUG ARTICOUPLE PAD INSTALLATION



BERARD HEAVYLIFT TRANSLATION ONTO BARGE



TUG MACKIE TRANSLATION AND LAUNING

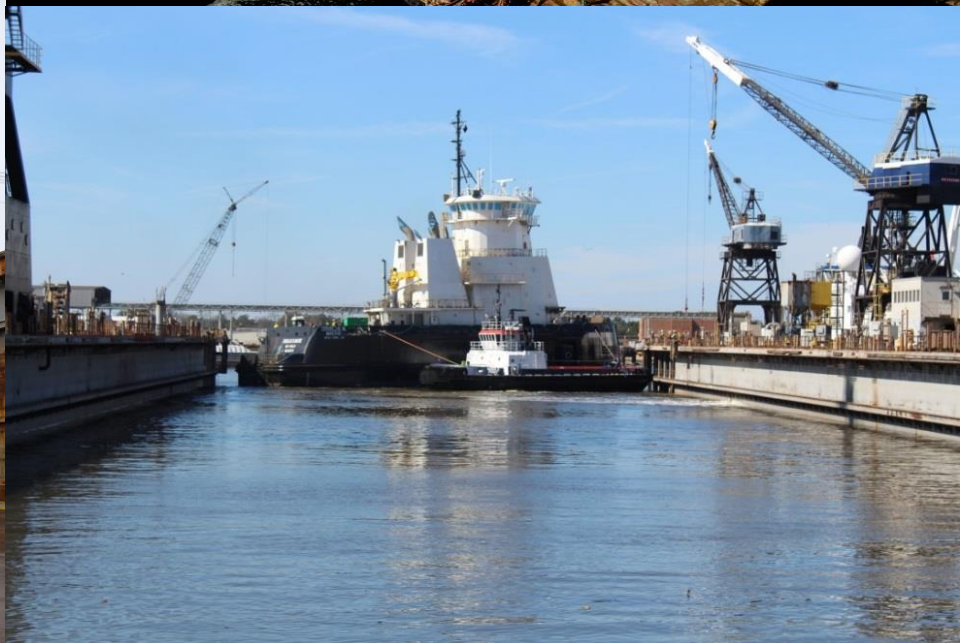
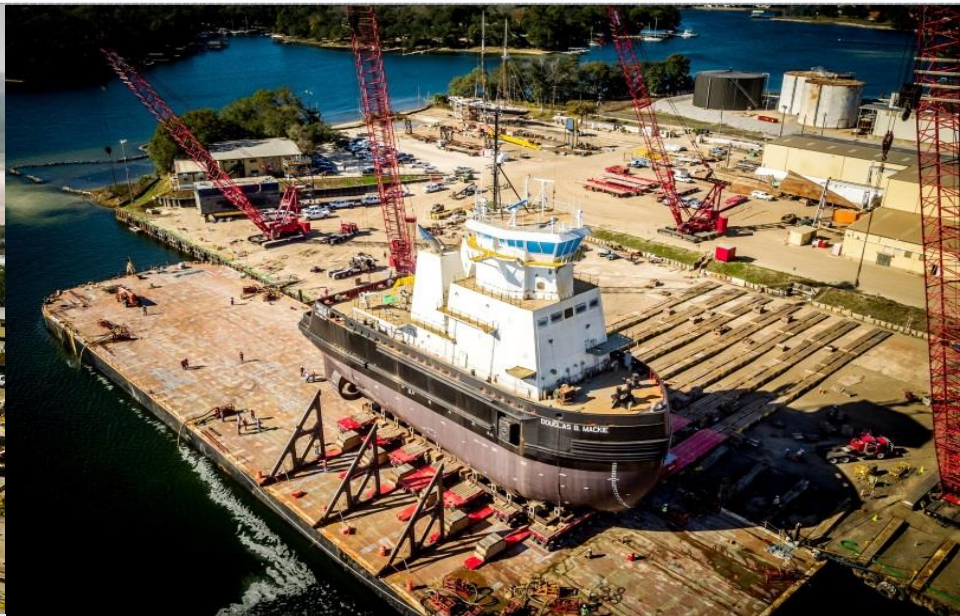
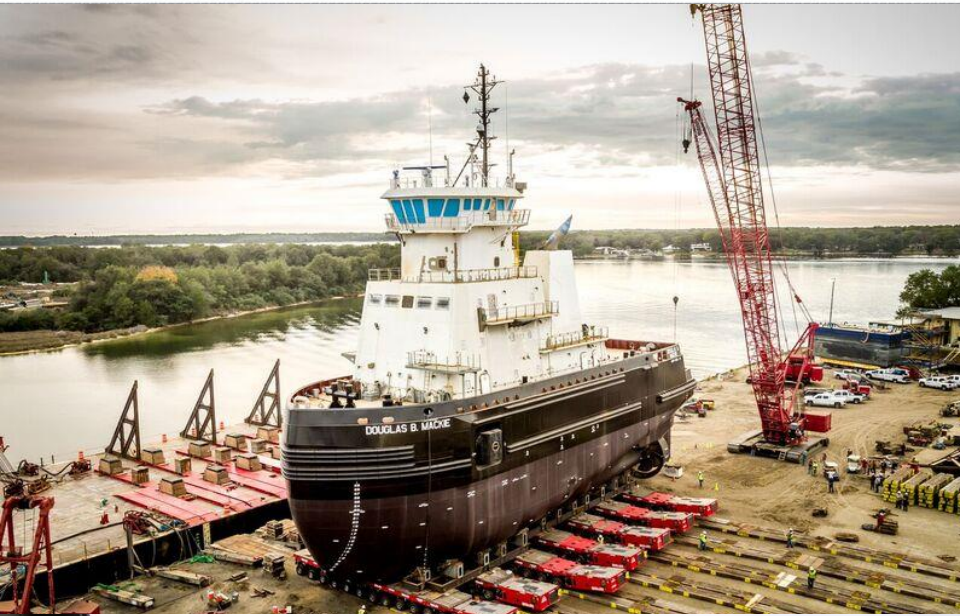

TUG NAVIGATION BRIDGE

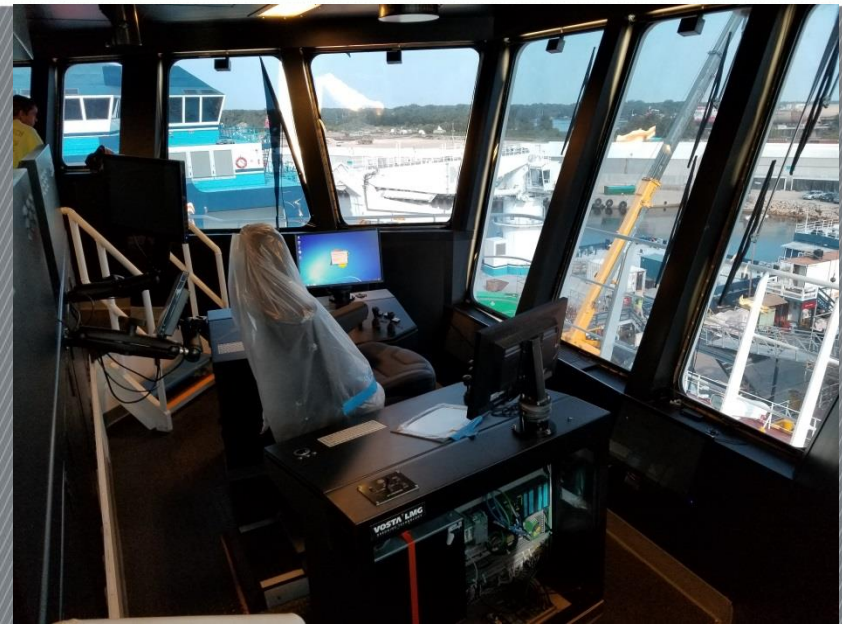

ENGINEERING DECK



TUG SEA TRAILS 5 OCTOBER 2017



Barge Units

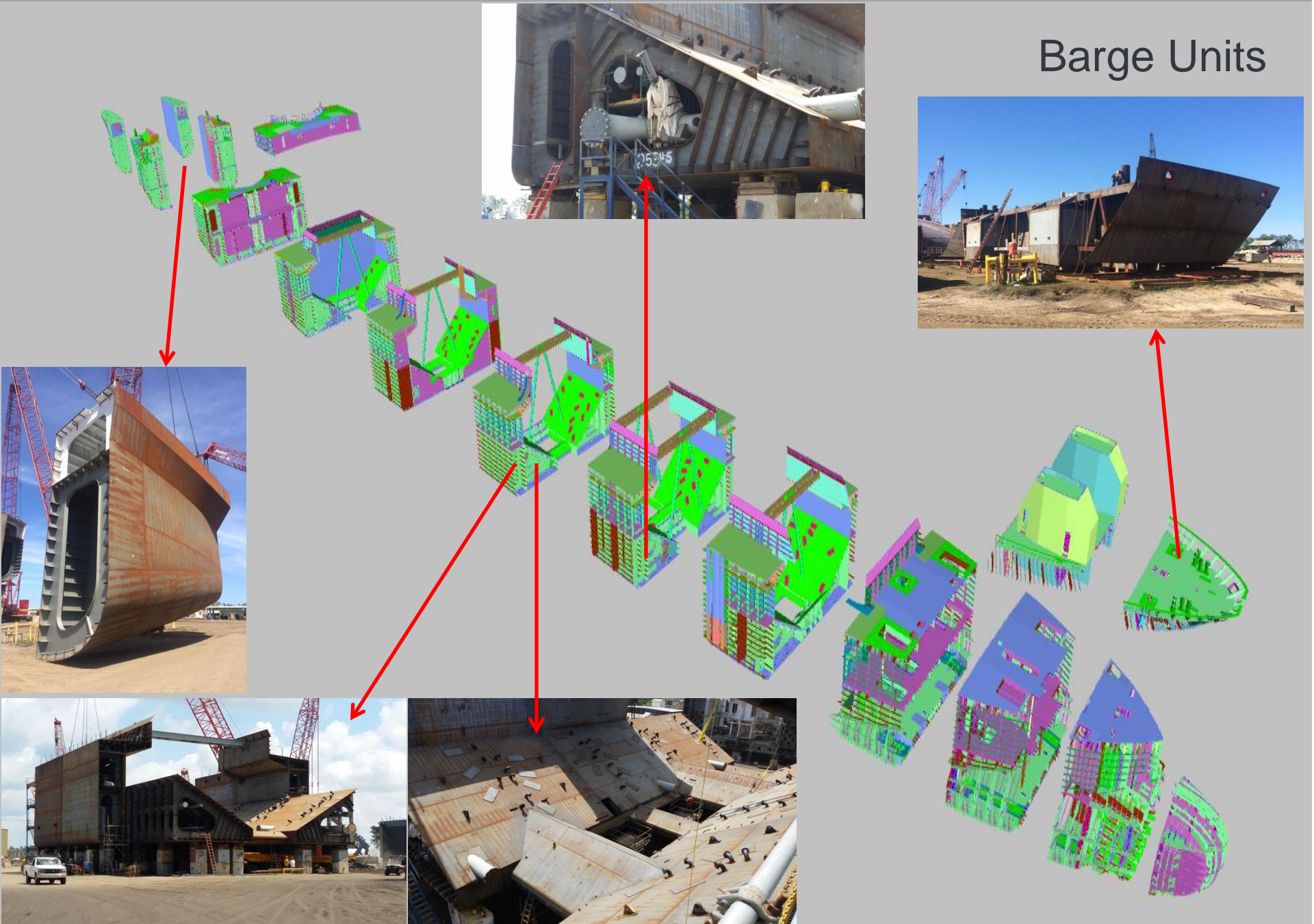

ATB Barge *Ellis Island* 3D Model of Hopper

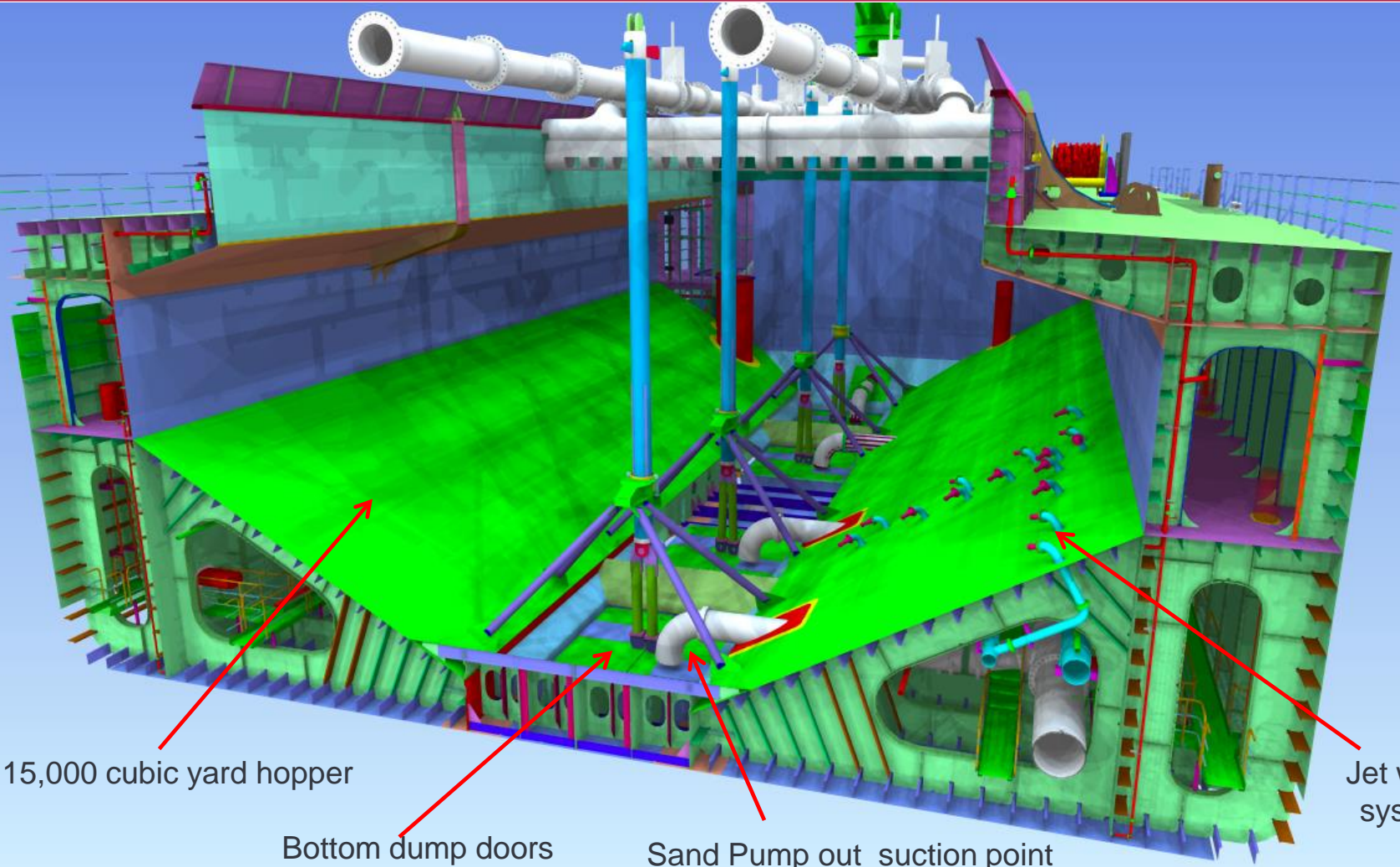

15,000 cubic yard hopper

Bottom dump doors

Sand Pump out suction point

Jet water system

Partially Constructed Hopper



Pump Out Suction Pipe

Bottom Dump Doors

Jet Water System

3D Model of Pump Room

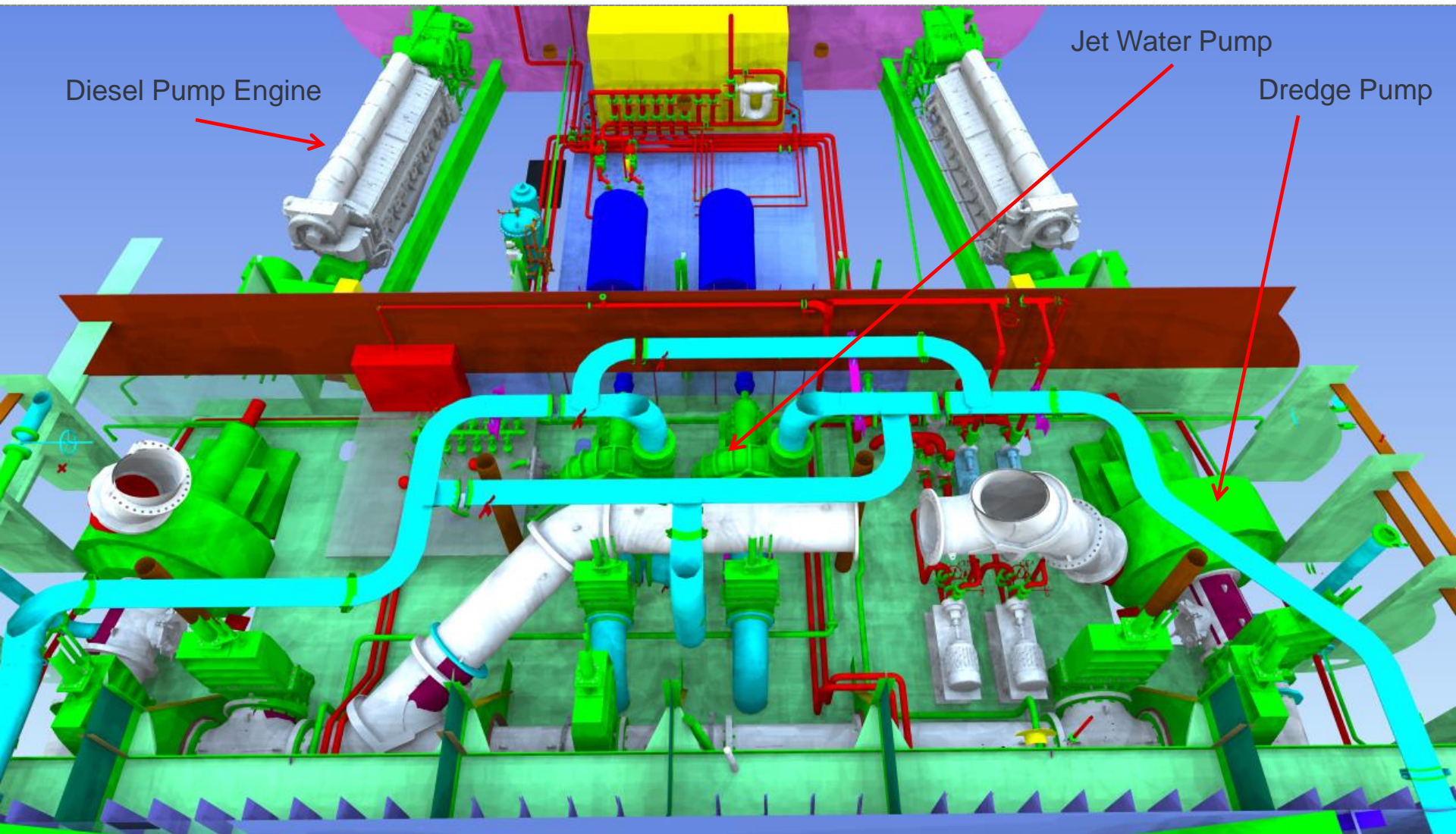

Diesel Pump Engine

Jet Water Pump

Dredge Pump

Pump Engines



Dredge Pump Engines

04/14/2016

ELLIS JET PUMPS AND 36" GIW DREDGE PUMP



GREAT LAKES DREDGE
& DOCK CORPORATION



INFRASTRUCTURE SOLUTIONS | INFO@GLDD.COM |
GLDD.COM



Bow Erection Sequence



BOTTOM DUMP DOORS



PREP FOR SIDE LAUNCH



LAUNCH 30 SEPTEMBER 2016



GREAT LAKES DREDGE
& DOCK CORPORATION

INFRASTRUCTURE SOLUTIONS | INFO@GLDD.COM |
GLDD.COM

ELLIS FORE DECK



Commissioning Starboard Drag Arm



6.6kv SYSTEM COMMISSIONING



ELLIS HOPPER DECK



ELLIS ISLAND TESTING VOSTA DREDGE CONTROL AUTOMATION



3000 HP HOPPER JETTING SYSTEMS TESTS



VIEW FROM TUG BRIDGE



TUG MACKIE AND ELLIS ISLAND AT OUTFITTING PIER



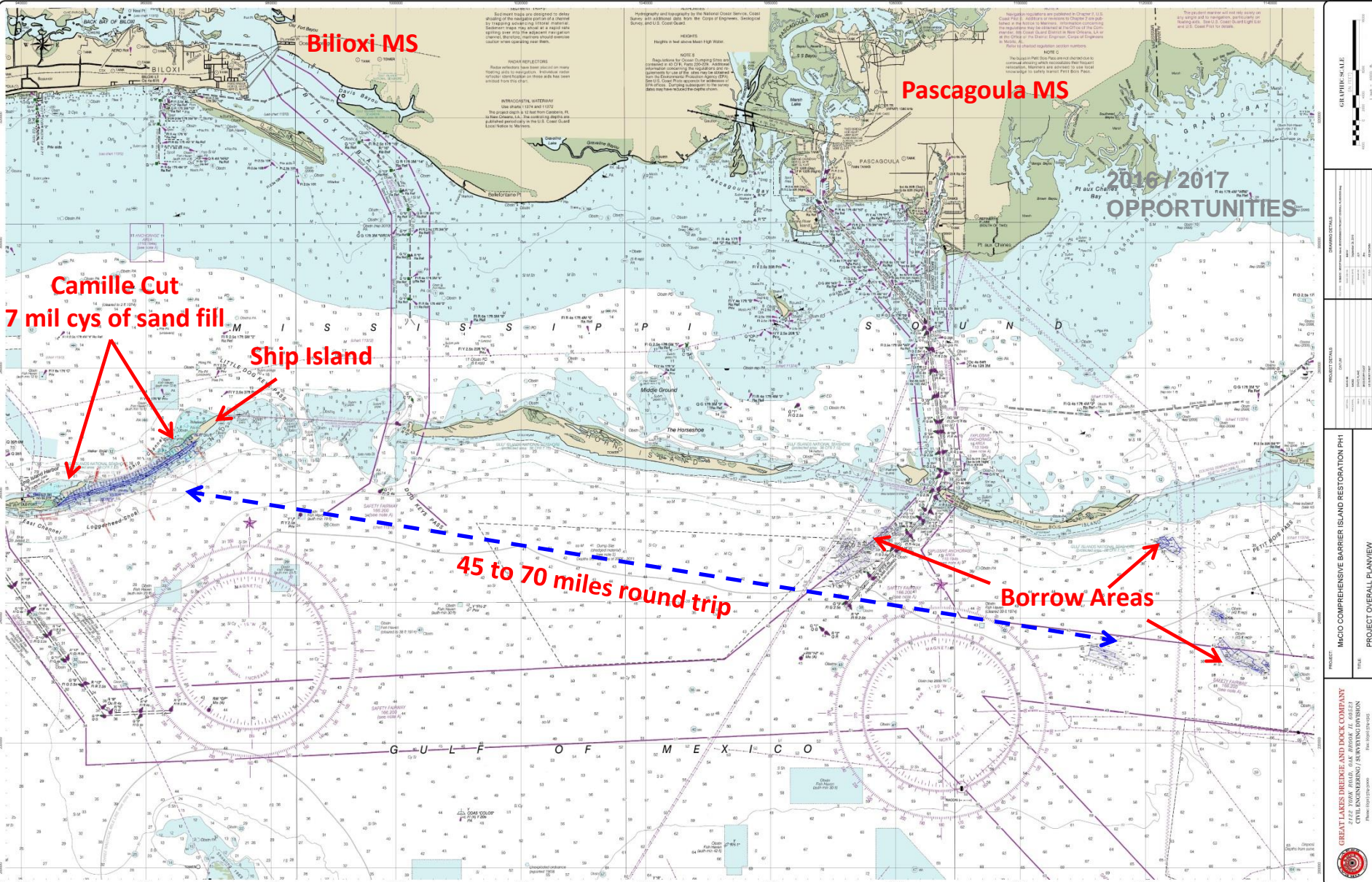

Coastal Protection – Hurricane Camille Cut Ship Island MS

MSCIP Phase 1



GRAPHIC SCALE

PROJECT DETAILS

PROJECT OVERALL PLANVIEW

PROJECT: MICRO COMPREHENSIVE BARRIER ISLAND RESTORATION PH1

CLIENT: GREAT LAKES DREDGE AND DOCK COMPANY

FILE: MSCIP PHASE 1

DATE: 10/20/2016

PROJECT: MICRO COMPREHENSIVE BARRIER ISLAND RESTORATION PH1

CLIENT: GREAT LAKES DREDGE AND DOCK COMPANY

FILE: MSCIP PHASE 1

DATE: 10/20/2016

PROJECT OVERALL PLANVIEW

Change in Industry Capacity

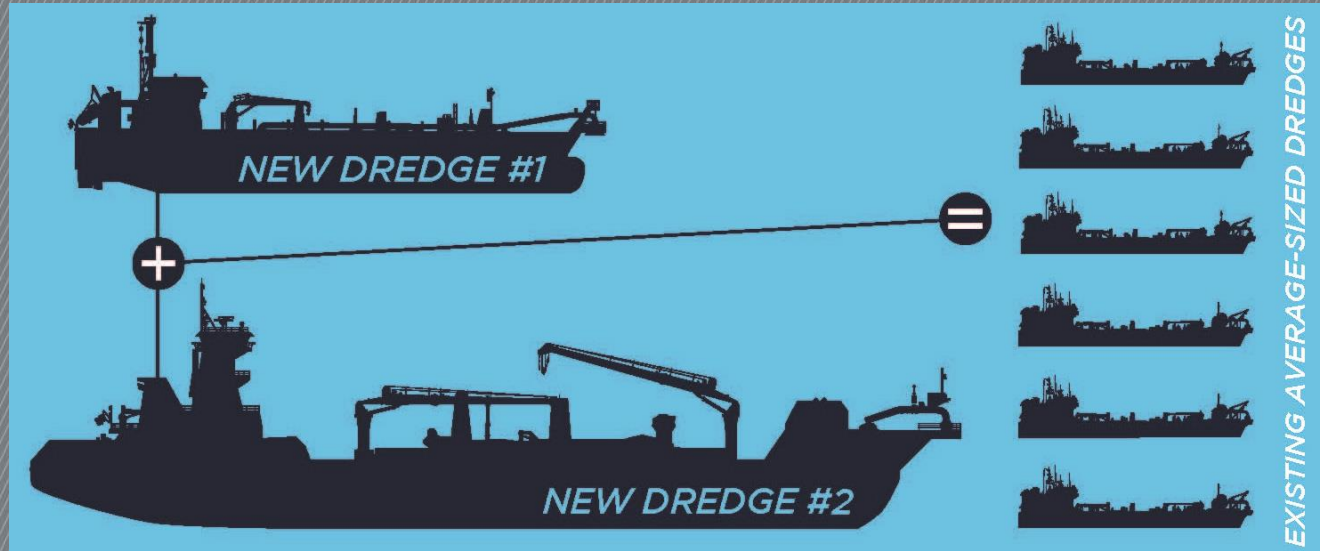

Historical Industry Capacity (1997-2015) – 66,340 cy

Industry Capacity with Weeks and GLD&D Newbuilds – 90,040 cy