

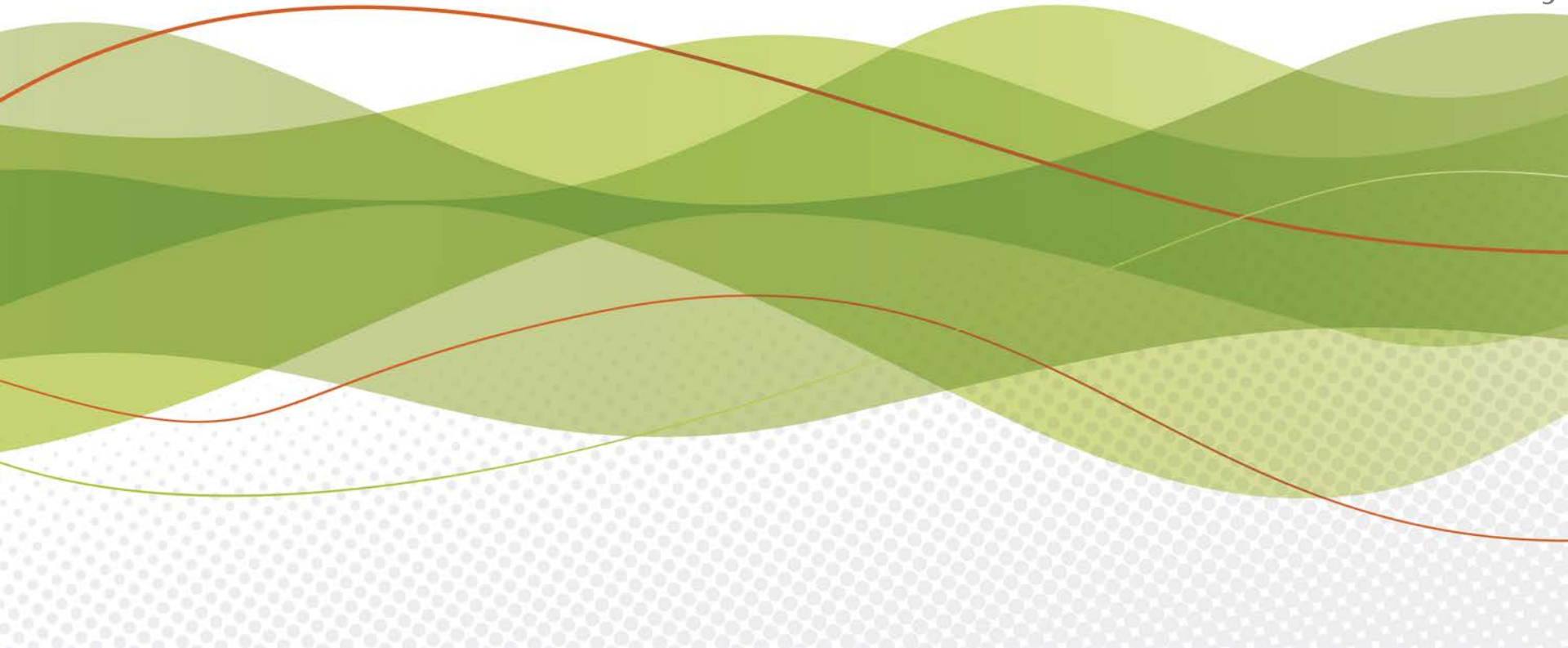

# Precision Methods for Managing Contaminated Sediment

Erik Bakkom, P.E.

Connor Lamb, Madi Novak,  
Josh Elliott, and Mike Murray



# Port of Ridgefield, Washington

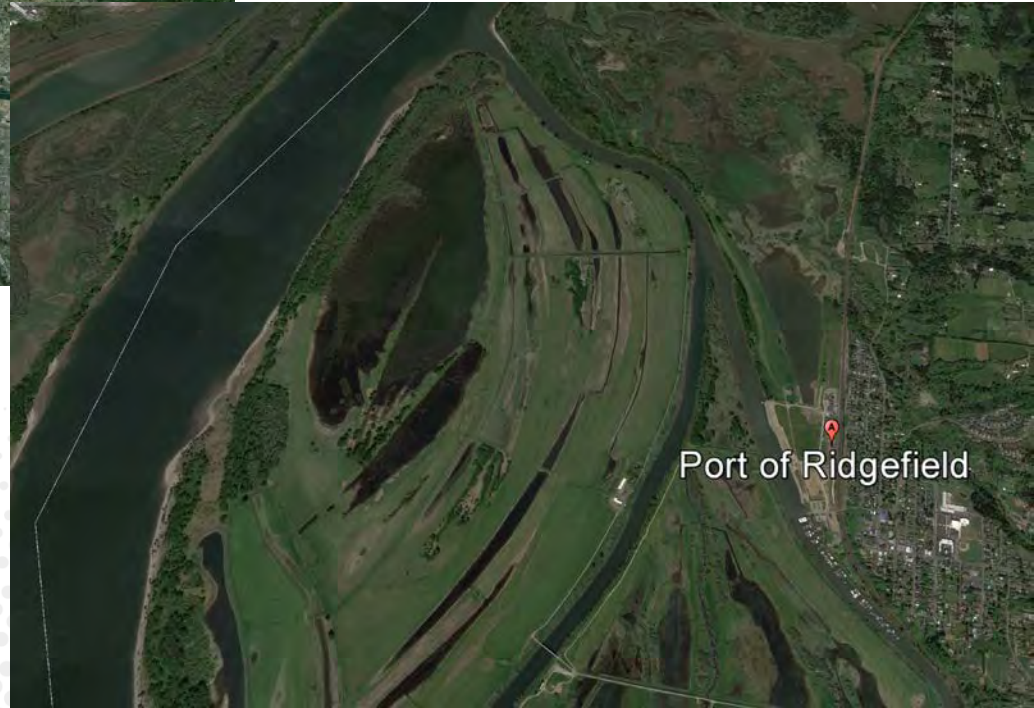
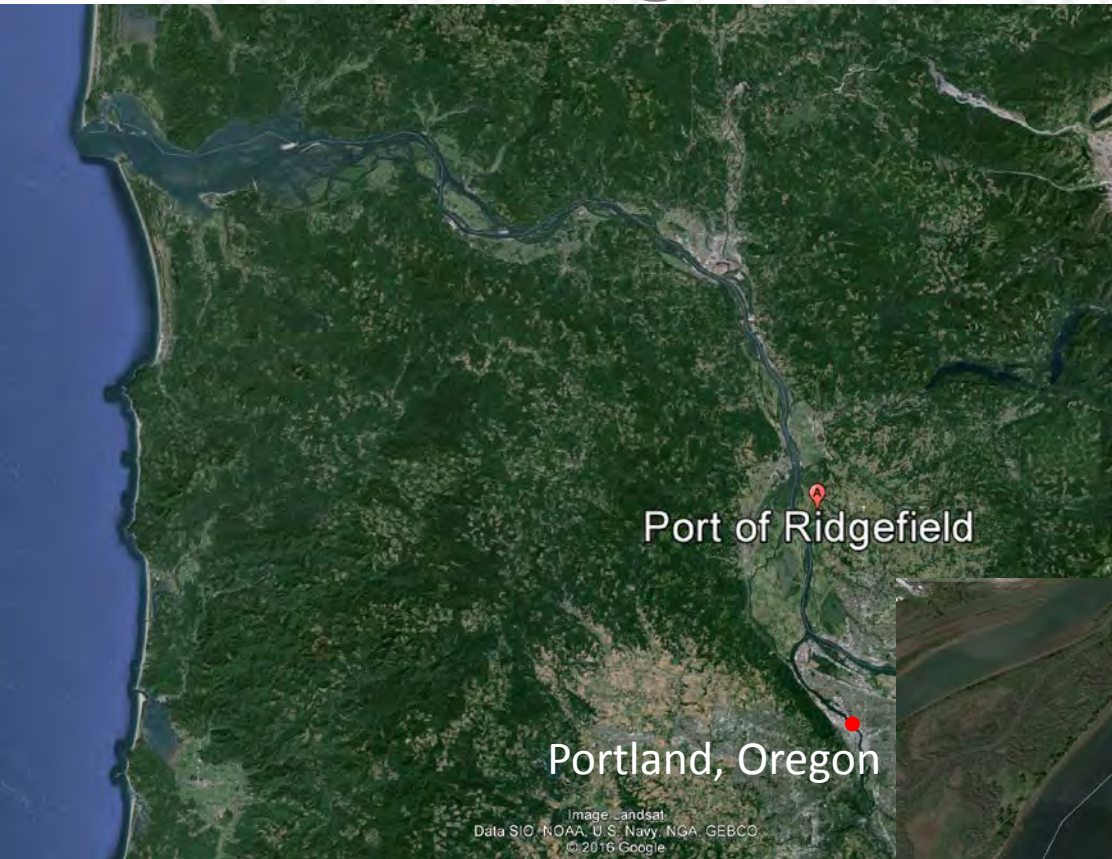

# Once Upon a Time

---



# Remedial Action Delineation

- o Convert selected IDW interpolation into grid cells (majority method) appropriate for dredge implementation (i.e., bucket size)
- o Adjust final areas based on BPJ and other considerations (e.g., DNR input, archeological considerations)

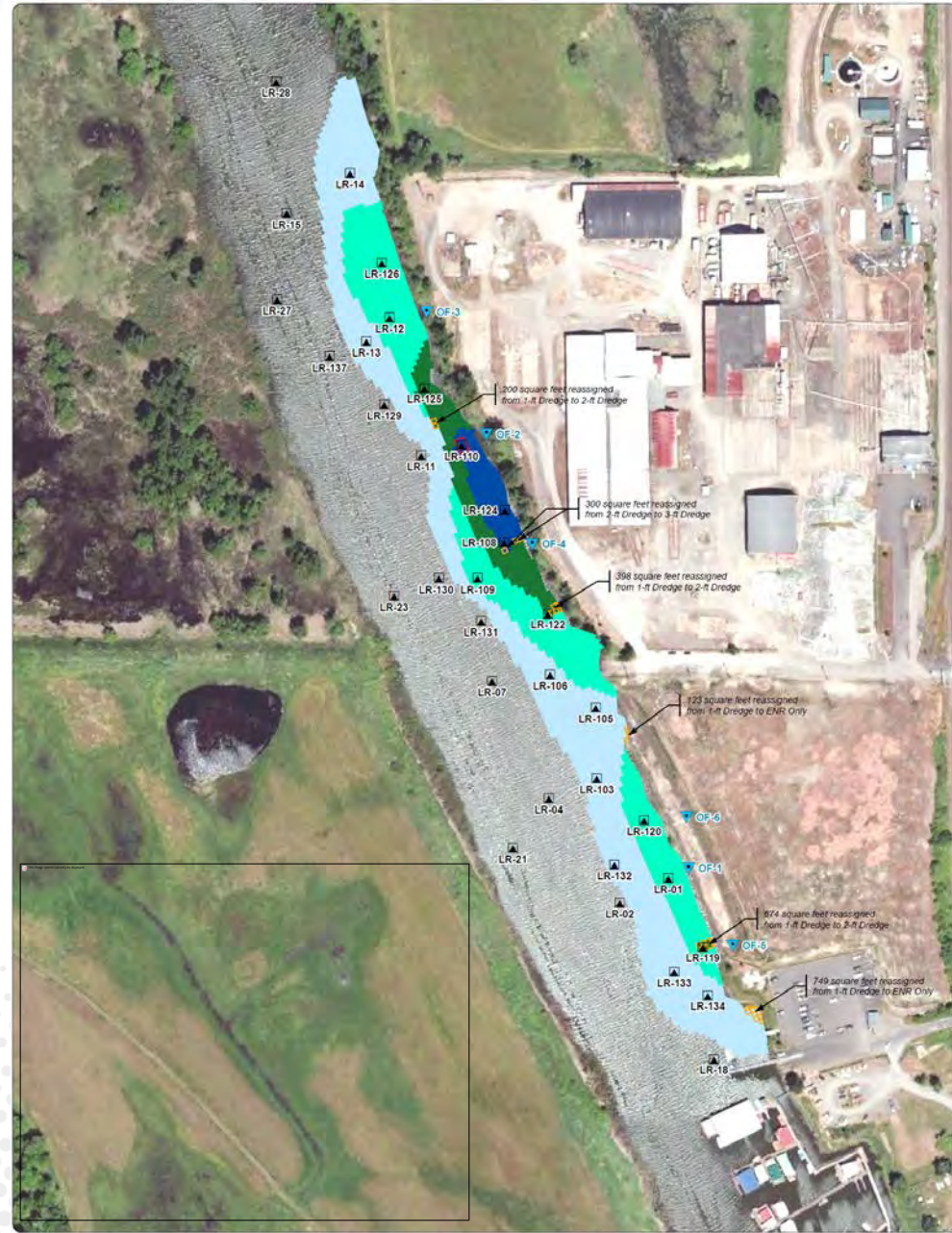



The need to increase precision associated with environmental dredging (compared to that needed for navigation dredging) is well recognized. USACE states that:

*...the key to a successful environmental dredging project is the removal of the “target layer” without excessively removing clean material.*

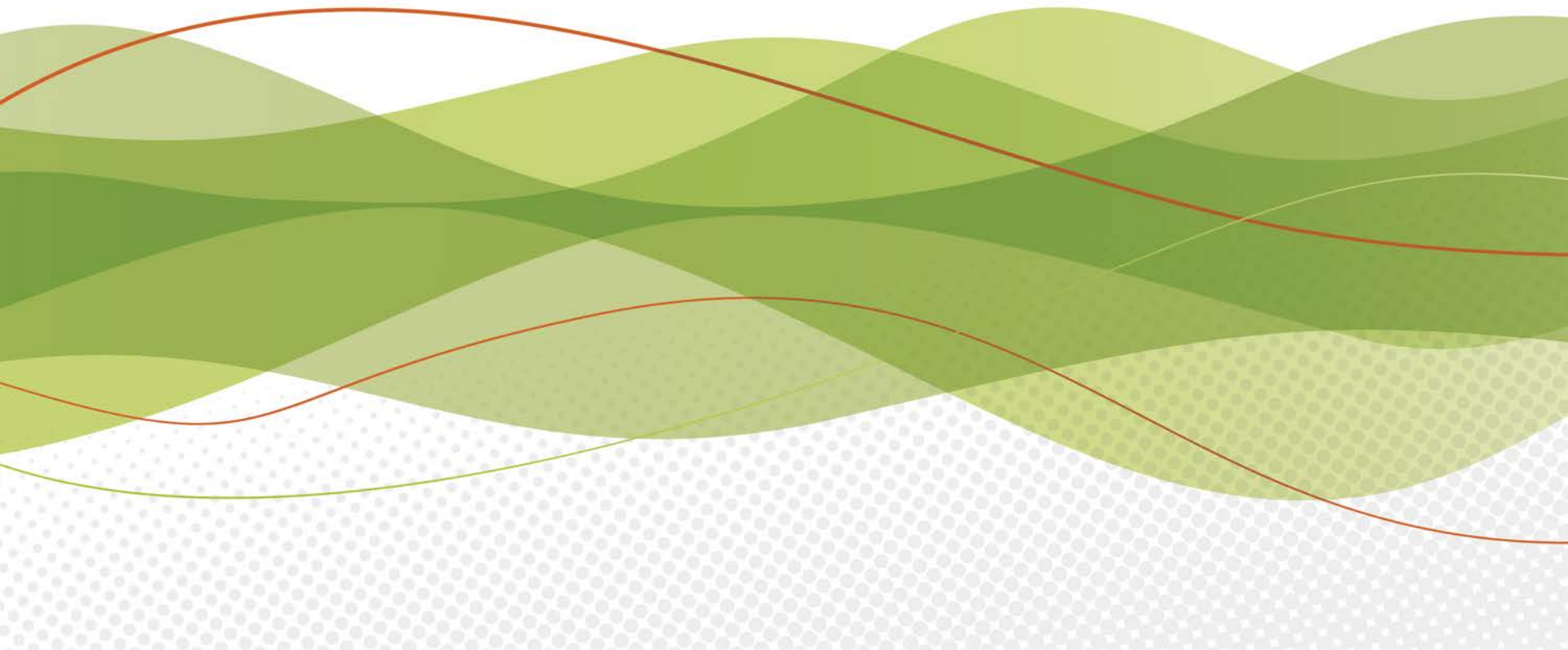

# Dredge Prism Development

Apply results of remedy delineation to bathymetry

- **Detailed bathymetric survey** timed to follow pre-design sampling - sample depths converted to fixed elevations
- **Depths adjusted** to account for compaction during sampling
- Interpolation results converted to **offset surfaces**
- **Extent of contamination** surface is developed to evaluate completion during construction

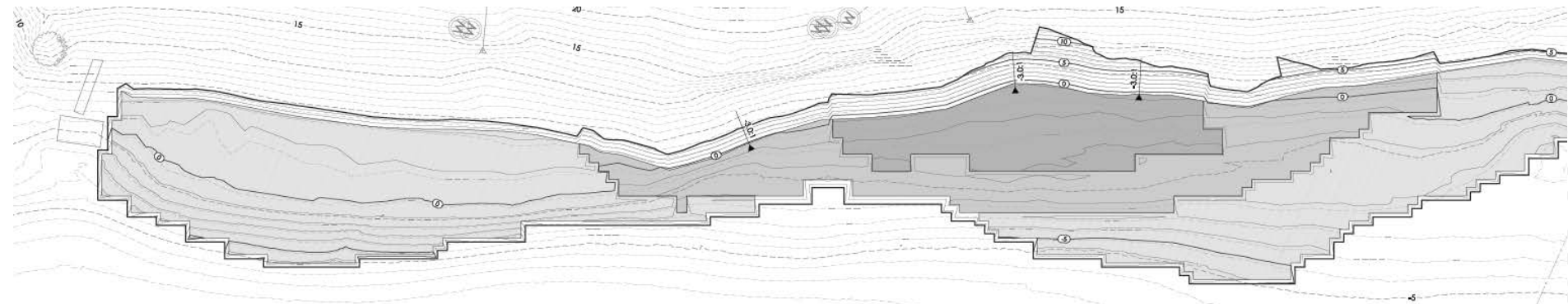

# Dredge Prism Development

Dredge grid superimposed on neatline surface

- Designed with specific dredge equipment in mind
  - Bucket dimensions with overlap
  - Lowest elevation for entire cell
- Limit sediment instability and generation of dredging residuals
  - Undercutting and sloughing
  - Adjacent cells not more than 1-foot
- 2890 cells
- Dredge grid used by contractor as bucket targets for “neatline surface”





# Dredge Prism Development

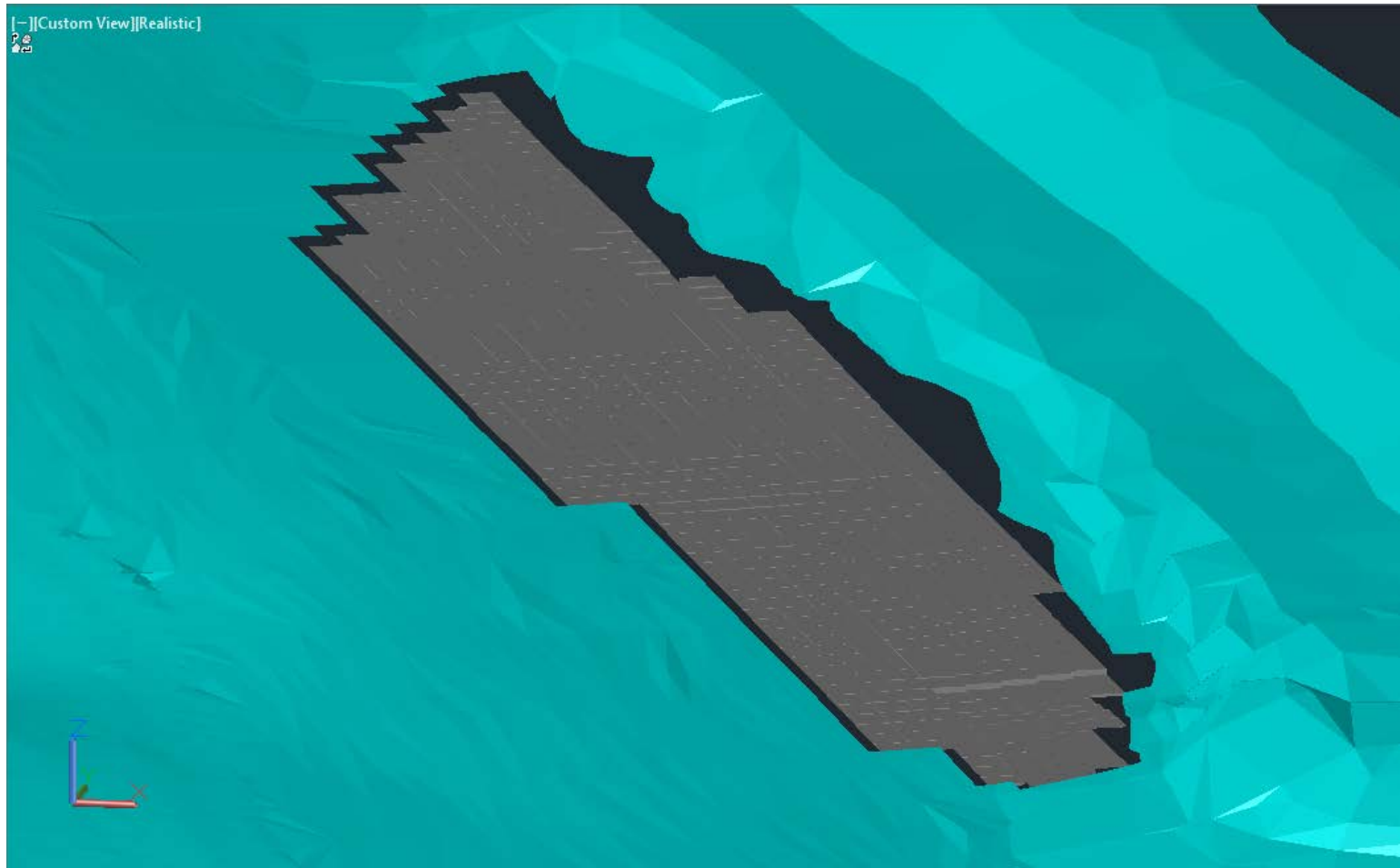

# Contaminated Sediment Removal

*Vertical control may be particularly important when contamination occurs in a relatively thin or uneven layer.*

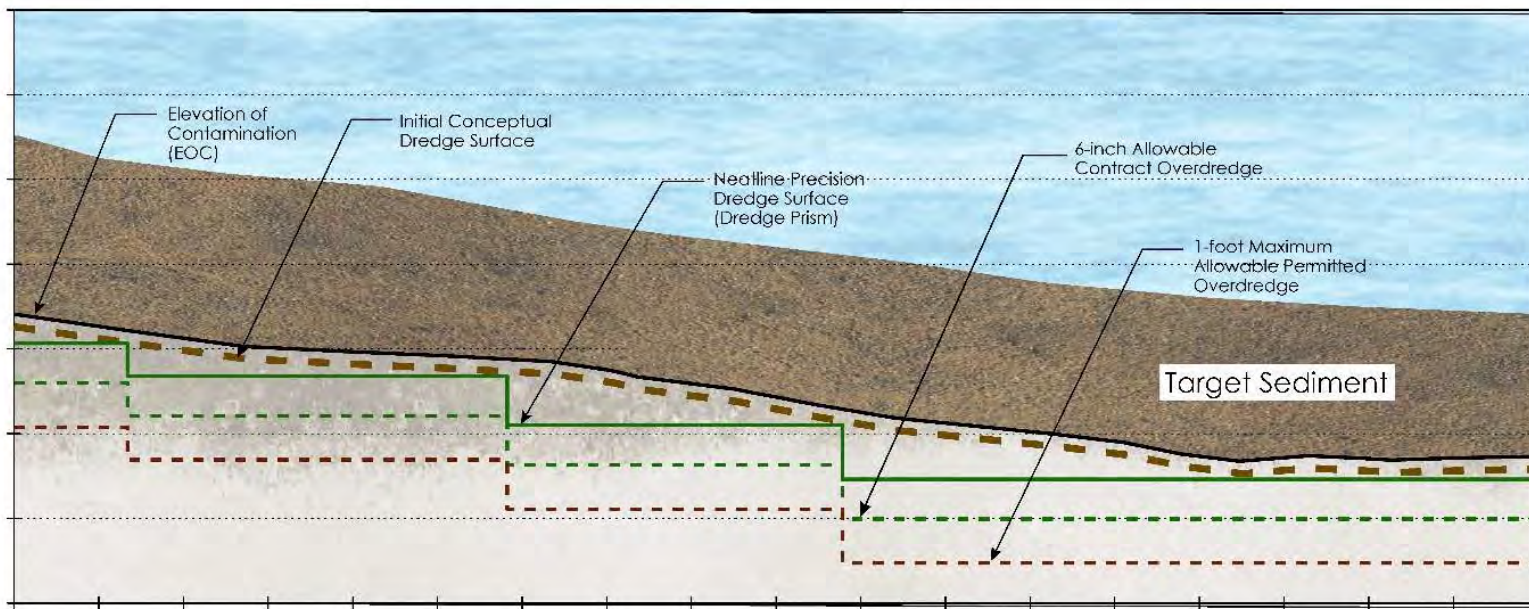

## LEGEND

|       |                                   |   |                    |   |                                  |
|-------|-----------------------------------|---|--------------------|---|----------------------------------|
| —     | EOC                               |  | Lake River         |  | Sediment to be Removed (Dredged) |
| - - - | Initial Conceptual Dredge Surface |  | Sediment to Remain |   |                                  |
| —     | Neatline Precision Dredge Surface |   |                    |   |                                  |
| - - - | Allowable Contract Overdredge     |   |                    |   |                                  |
| - - - | Maximum Permitted Overdredge      |   |                    |   |                                  |



# What is Precision Dredging?

In terms of precision, it is reasonable to plan on overall dredging accuracy of no better than +/- 6 in. vertical and horizontal if:

- ❑ Well defined dredge prism as target.
- ❑ RTK-GPS-based positioning systems are employed.
- ❑ A fixed arm or ladder dredge is used.
- ❑ Experienced and skilled operators are employed.
- ❑ There is limited debris and obstruction to dredging.
- ❑ Quality control system to verify the positioning system at least once per day throughout the full range of motion.

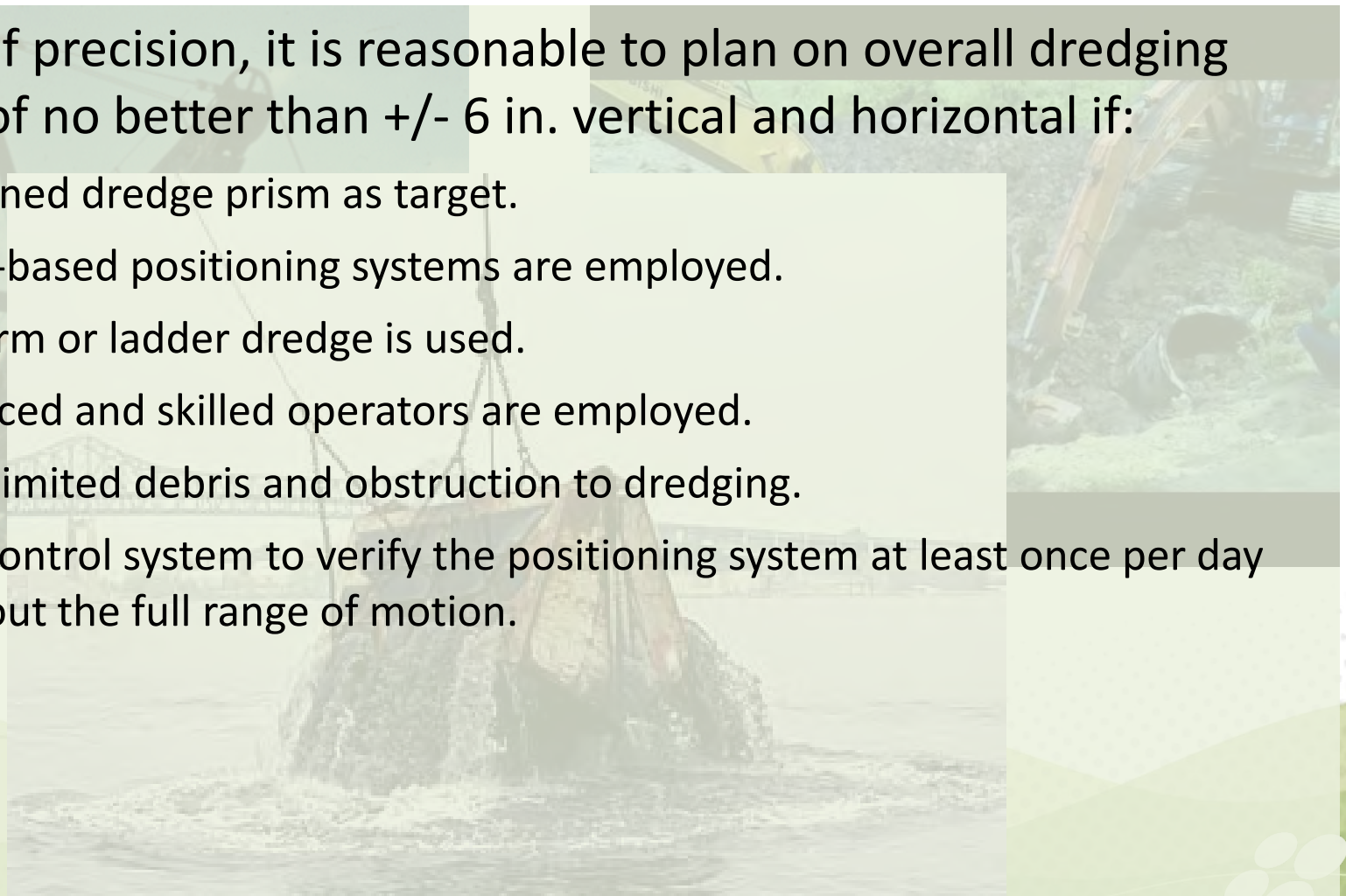

# What is Precision Dredging?

Fully-enclosed & vented, double-arc rehandling bucket with hydraulic articulation control



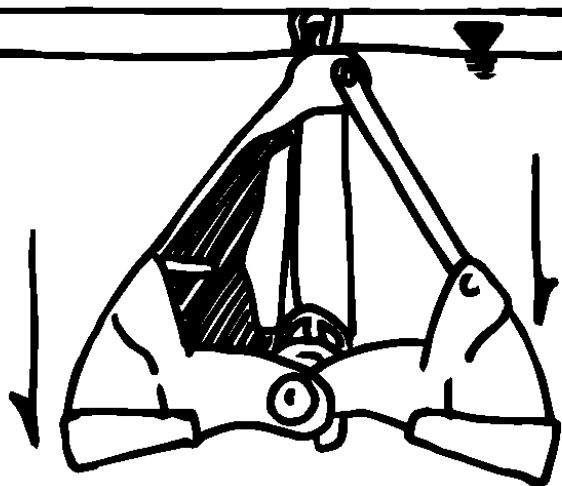

BUCKET DECENDS THROUGH WATER COLUMN

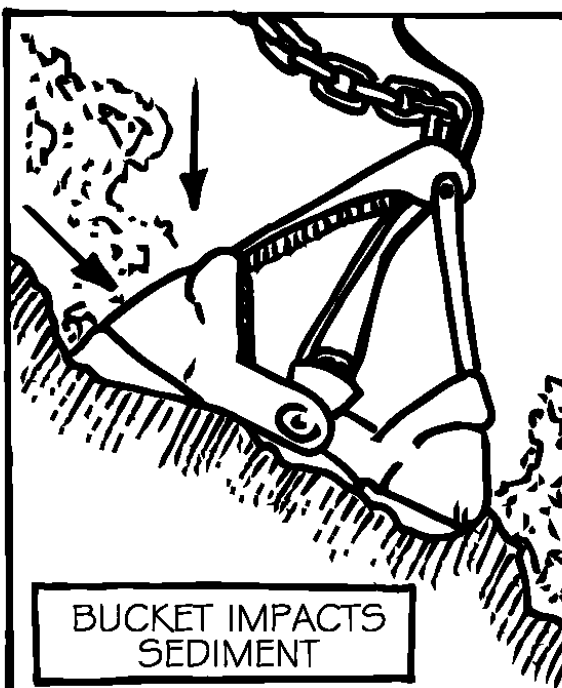

BUCKET IMPACTS SEDIMENT

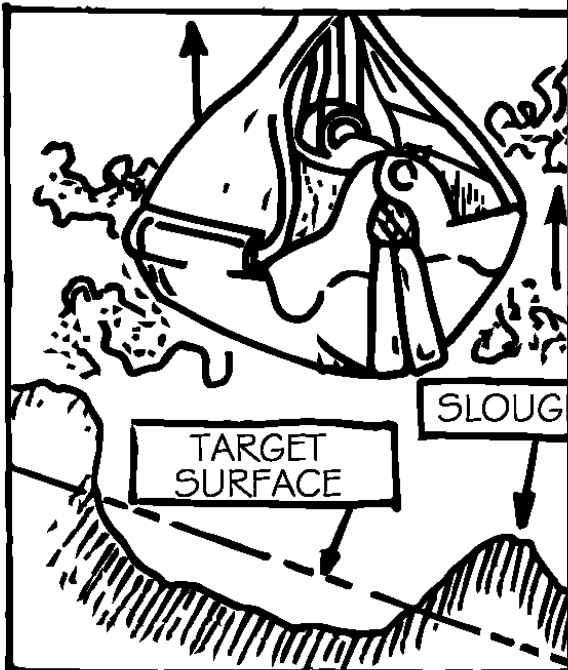
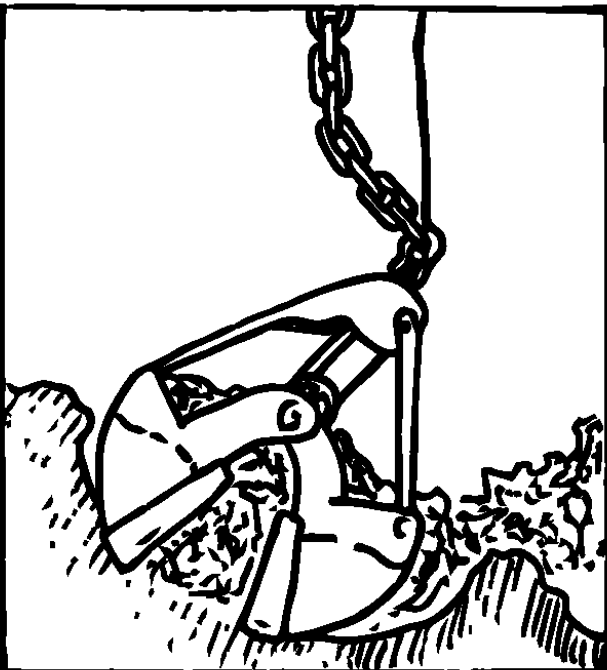
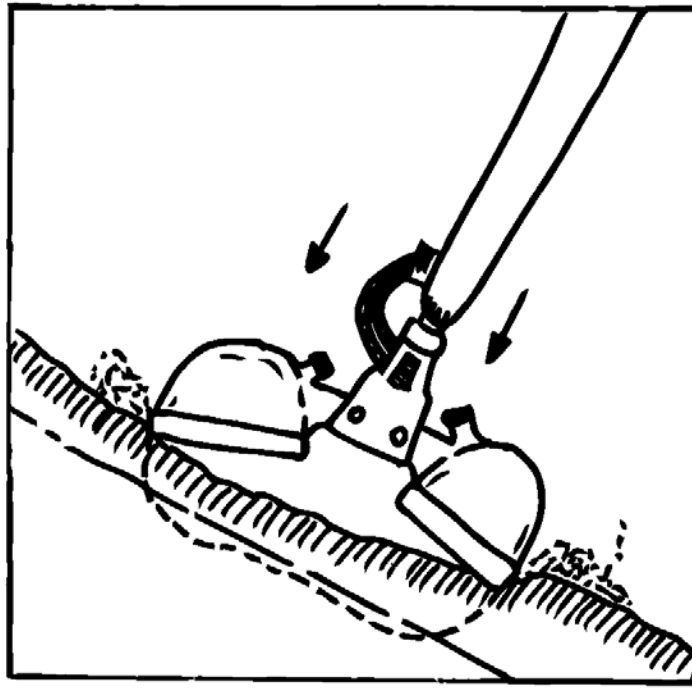

TARGET SURFACE

SLOUGH

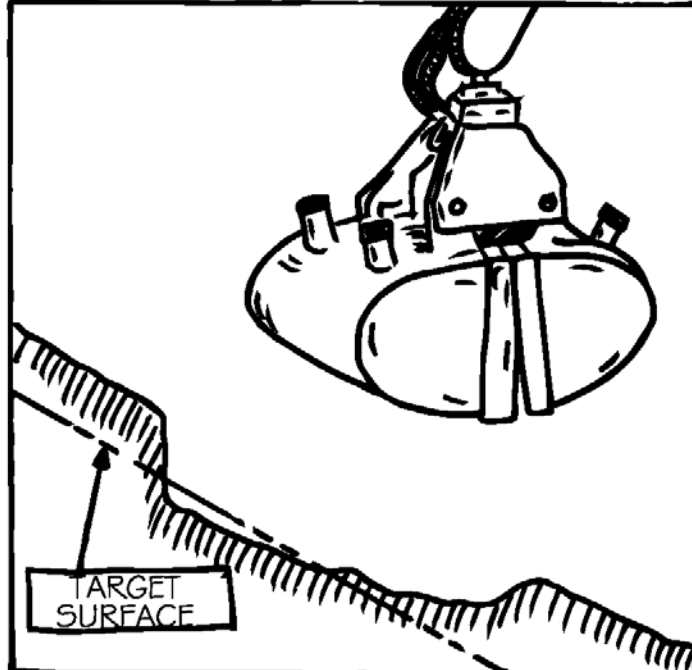

TARGET SURFACE

# What is Precision Dredging?

## Prescriptive?

In addition to increasing precision, implementation of this method addresses resuspension, residuals, release and risk:

- Resuspension (water quality)
- Release (of contaminants)
- Residuals (missed and generated)
- Risk
  - ▣ Owner, Stakeholders, the Public



# What is Precision Dredging?

Fully-enclosed & vented, double-arc rehandling bucket with hydraulic articulation control

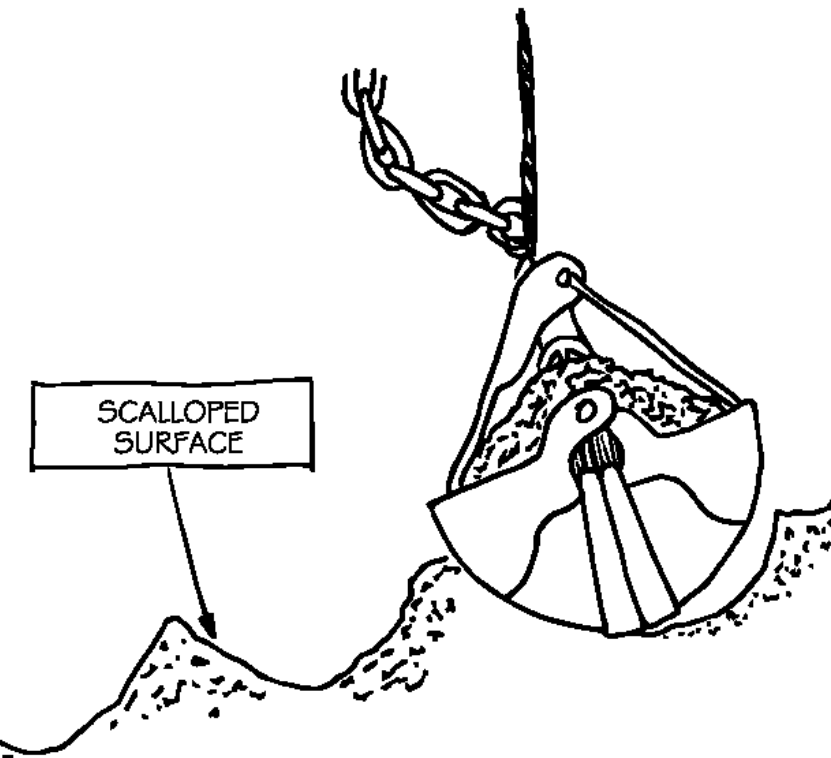

TRADITIONAL CLAMSHELL BUCKET

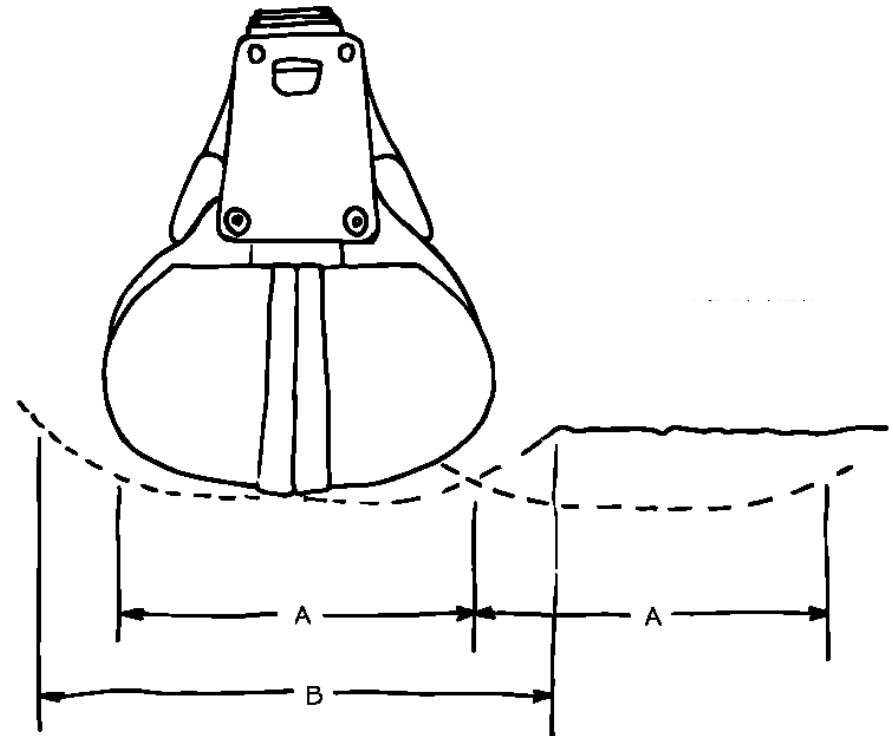

BUCKET PROFILE  
SECTION VIEW (NTS)

# What is Precision Dredging?

## Dredge prism design

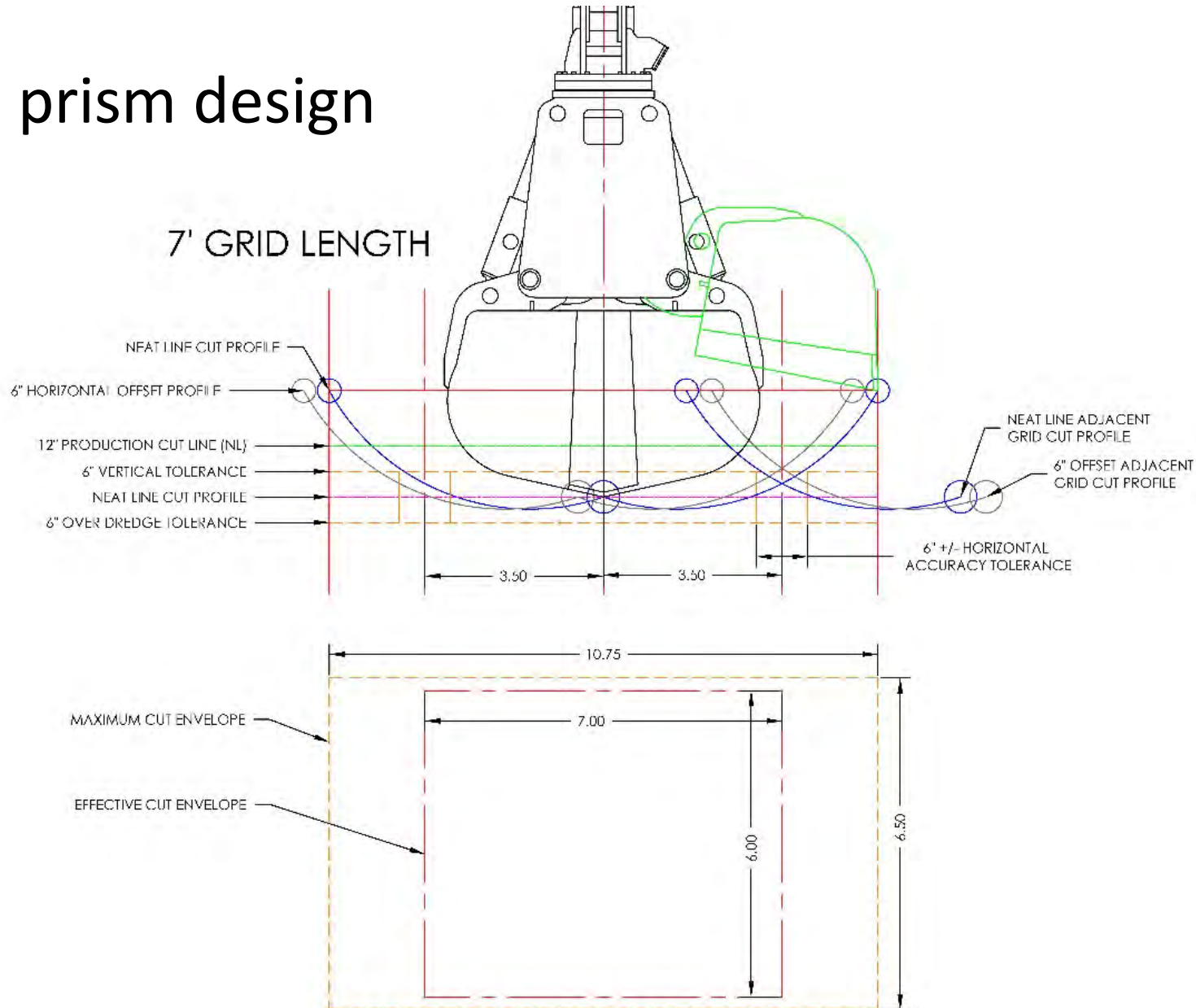



# What is Precision Dredging?

## Dredge prism design

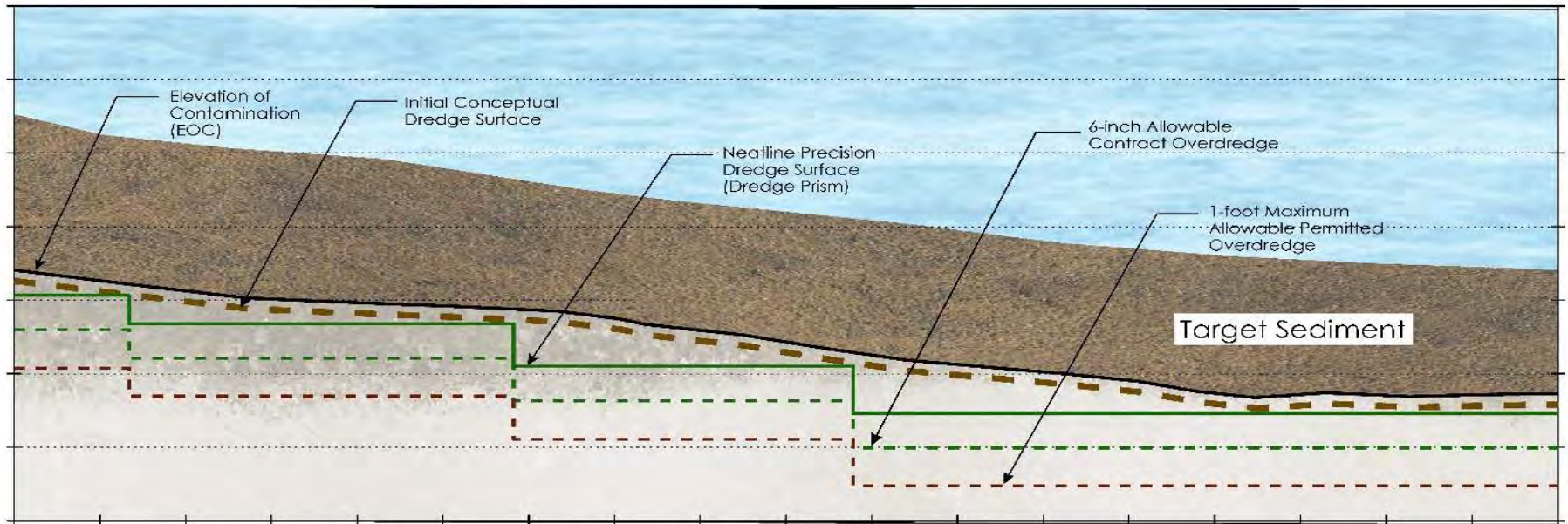

### LEGEND

- |       |                                   |   |                    |   |                                  |
|-------|-----------------------------------|---|--------------------|---|----------------------------------|
| —     | EOC                               |  | Lake River         |  | Sediment to be Removed (Dredged) |
| - - - | Initial Conceptual Dredge Surface |  | Sediment to Remain |   |                                  |
| —     | Neatline Precision Dredge Surface |   |                    |   |                                  |
| - - - | Allowable Contract Overdredge     |   |                    |   |                                  |
| - - - | Maximum Permitted Overdredge      |   |                    |   |                                  |

# What is Precision Dredging?

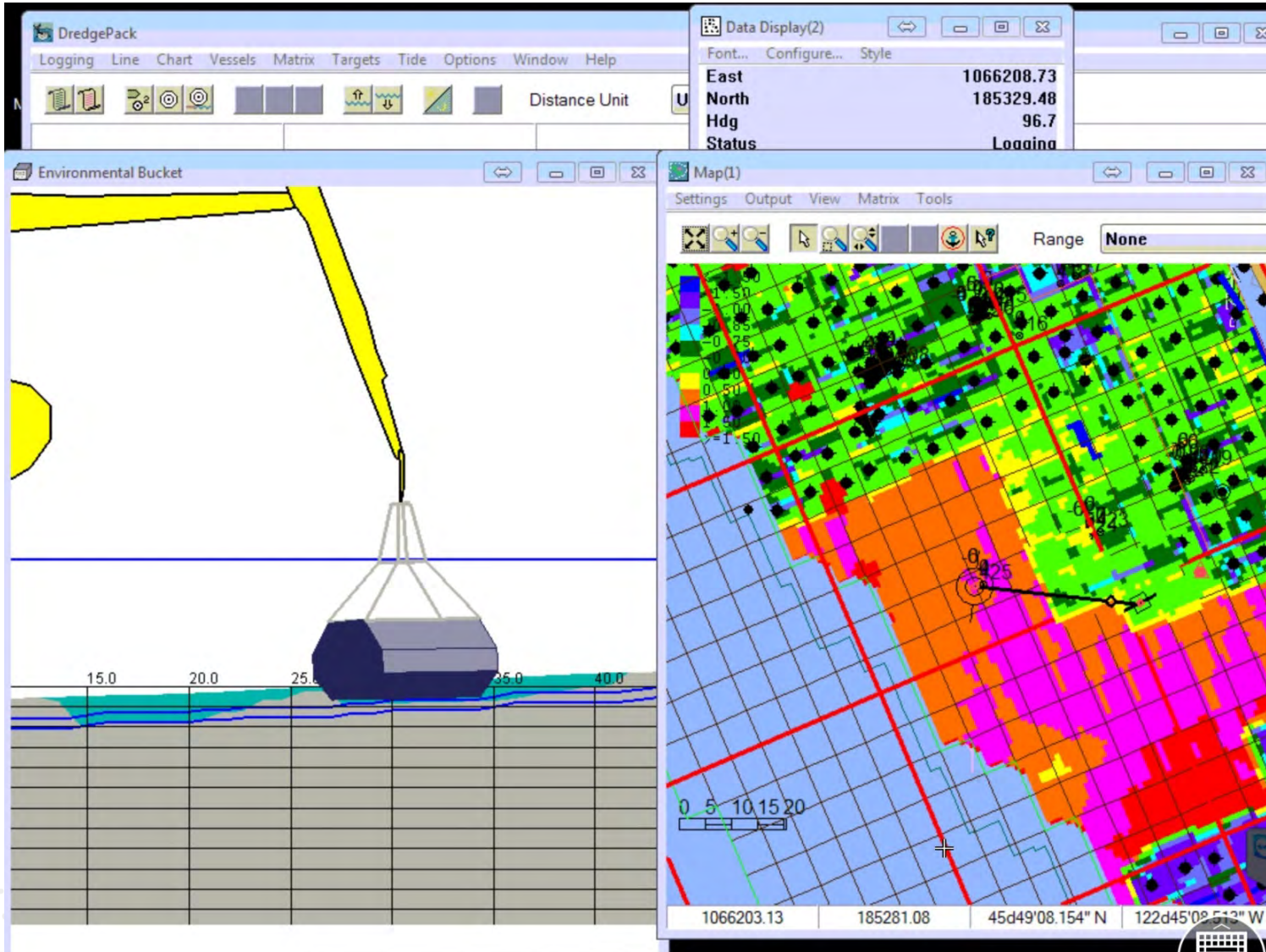

# Implementation and Operational BMPs

Targeted structure and debris removal prior to dredging



# Implementation and Operational BMPs

Continuous oversight of each component was conducted to verify that the design intent was met while adjusting to field conditions



Placing fish mix on shoreline.



Dredging, sand placement, and fish mix placement during Ecology visit.



Removing log while dredging.



Measuring freeboard of sand barge at sand placement operation.



# Precision Dredging

Method works as advertised – very little turbidity generated

- Clean stable cuts
- No turbidity curtain required/used
- Precision supported
  - NOAA
  - Washington



Ecology



# Water Quality Monitoring



- WQ Compliance – 300ft (upper, lower)
- Early Warning – 150ft (continuous readings)
- Success!
  - No shutdown due to water quality exceedances
  - No turbidity curtain/sheetpile



# Post-Remedy Monitoring

- o Applied Incremental Sampling Methodology
  - o Provides representative average concentration for large area
  - o Provides reproducible results  
=>important for long-term monitoring trend analysis
- o SWAC
  - o Target – 5 ng/kg (ppt)
  - o Results – 2.23, 0.56, 0.68 ng/kg



# Keys to Success

- Prescriptive
  - Well thought out, intentional design
  - Experienced people, advisors
- Continuous Oversight
  - Consistent record where we can “know” with more certainty
  - Presence is often all it takes
- Contractor Buy-In
  - All players of the same mind
  - Contractors appreciate being trusted with information
- Collaboration With the Agency
  - Ecology was on board early and proactive in working toward successful completion





# The Results



# Questions?

Erik Bakkom

[ebakkom@maulfoster.com](mailto:ebakkom@maulfoster.com)

503-501-5217

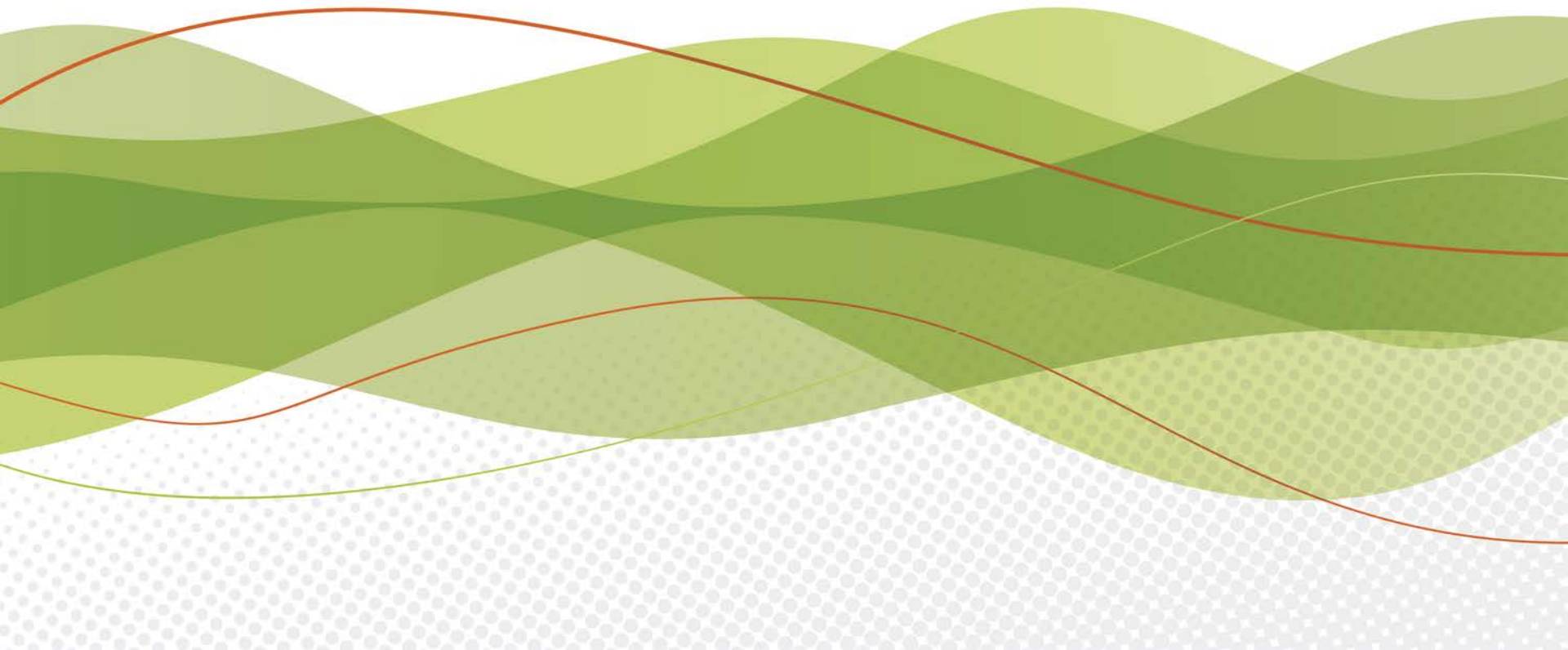

# Water Quality Monitoring



# Water Quality Monitoring

## Treated Water Discharge

- o Water Quality Certification AND Construction NPDES programs
  - Daily turbidity and pH compliance readings
  - Initial batches (2) and weekly analytical monitoring for dioxin surrogates
- o Water treatment system included real-time monitoring and ability to recirculate flows if turbidity or pH fell outside indicator levels.

