



中国交建  
CHINA COMMUNICATIONS CONSTRUCTION

# Analysis and Comparison of Resistance Models of Long-Distance Hydraulic Transport of Medium Sand



让世界更畅通

## ● About myself

- **Name:** Li Jinfeng
- **Age:** 29
- **Education :** Graduated from Ocean University Of China in the major of Hydraulic Engineering in 2013 with Master degree.
- **Work Unit:** CCCC Tianjin Dredging Co.,Ltd.
- **Position:** Assistant Engineer
- **Job Description:** Three years' work experience in dredging technics study and project management.
- **E-mail:** lijinfeng137@126.com

# Contents

- **Introduction**
- Particle motion patterns and hydraulic loss characteristics
- Resistance formula and basic theory
- Practical Calculation and Formula Evaluation

# ● Introduction

- Slurry transport consumes most of the installed power of CSD
- Accurate calculation of the hydraulic loss is important for forecasting dredger production and corresponding project progress

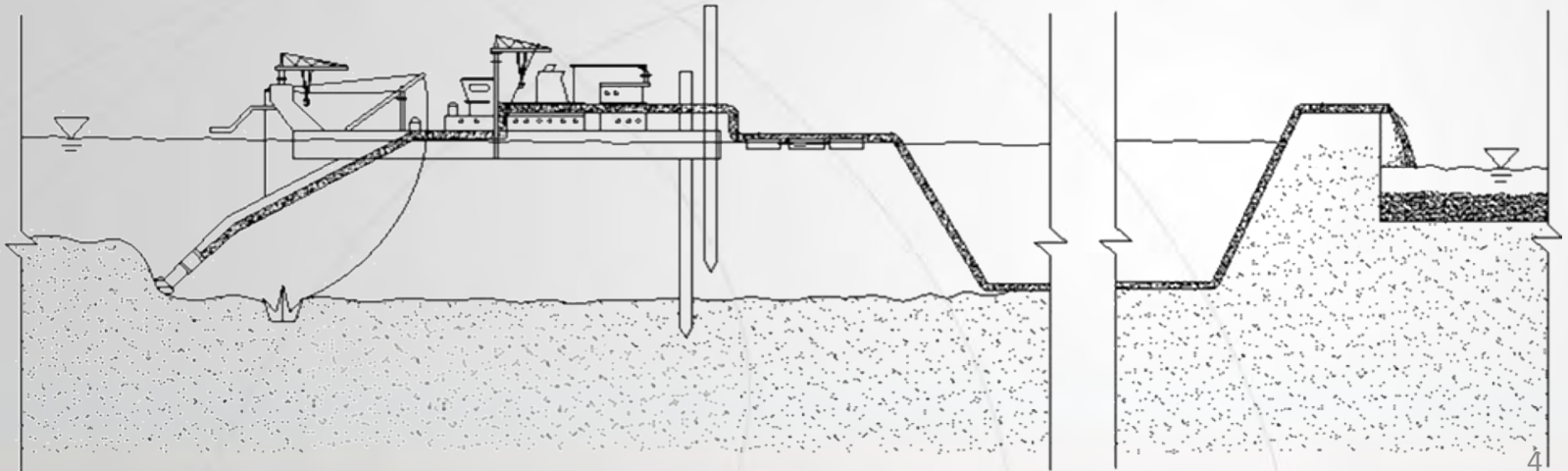
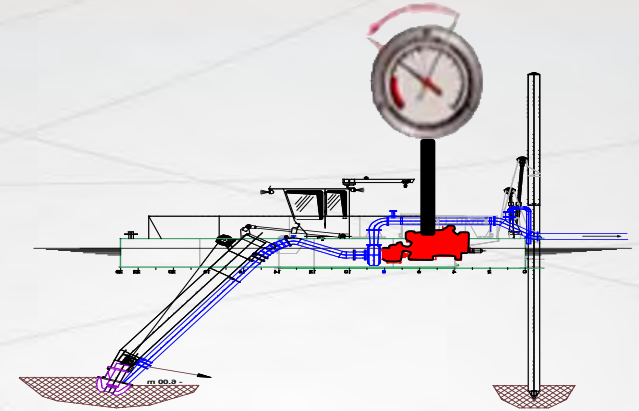

# ● Introduction

- Slurry transport is affected by the physical properties of particulate, flow state, flow pattern, flow properties, viscosity, pipe diameter and other factors of the solid particulate materials;

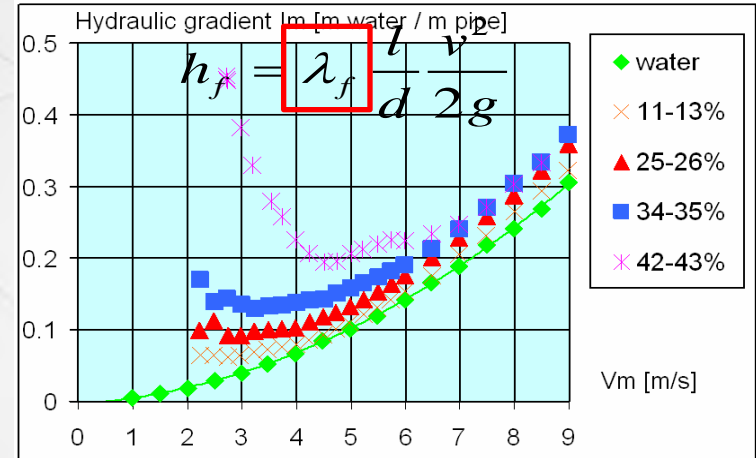
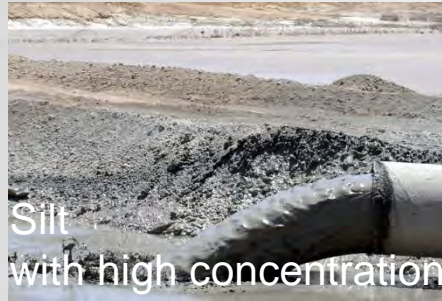

- There are a lot of formulas for calculating hydraulic loss during slurry transport process. Every formula has its own applicable conditions.
- To master the basic theories and applicable conditions of different calculation formulas will help to improve the estimation accuracy of the dredger production.



# Contents

- Introduction
- **Particle motion patterns and hydraulic loss characteristics**
- Resistance formula and basic theory
- Practical Calculation and Formula Evaluation

## ■ Particle motion patterns

- Quasi-uniform flow

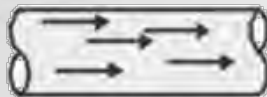

Quasi-uniform flow

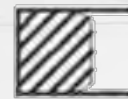

Velocity distribution



Concentration distribution

- Non-uniform flow



Non-uniform flow



Velocity distribution



Concentration distribution

- Composite flow

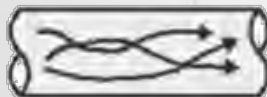

Composite flow



Velocity distribution



Concentration distribution



## ■ hydraulic loss characteristics

- For water, the hydraulic gradient “J” is proportional to the square of the flow rate
- for slurry, it can be divided into five distinct phases.

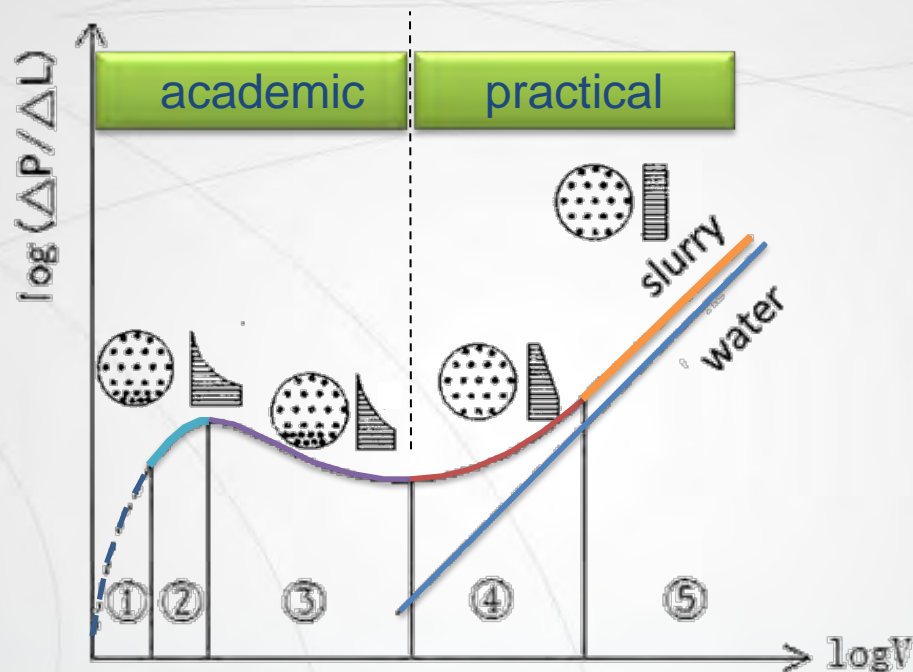

# Contents

- Introduction
- Particle motion patterns and hydraulic loss characteristics
- **Resistance formula and basic theory**
- Practical Calculation and Formula Evaluation

- The current formulas are mostly based on the combination of theory, experiment and statistics.
- A lot of trials and studies on hydraulic loss of slurry transportation have been conducted, and a number of empirical and semi-empirical formulas were proposed. These formulas can be divided into three categories:
  - ▣ Formulas based on diffusion theory: used for fine particles in low concentration
  - ▣ Formulas based on gravity theory: used for coarse particles
  - ▣ Formulas based on energy theory: combination of the above

## ■ Characteristic formulas

### □ Durand Formula

- based on gravitational theory
- The model is based on the following experiment conditions: soil particle size 0.18 ~ 22.5mm, pipe diameter 40 ~ 700mm ,particle concentration is 22%.
- The model expresses the resistance loss  $I_m$  consist of two parts:  $I_0$  represents pure water resistance loss , $I_s$  represents additional loss .
- Additional loss is related with Froude's number  $\frac{V}{\sqrt{gD}}$  of pipe flow. The relations between additional loss  $I_s$  and Froude's number  $\frac{V}{\sqrt{gD}}$  is determined through experiment.

## ■ Characteristic formulas

### □ Durand Formula

$$\frac{I_m - I_f}{I_f \cdot C_{vd}} = K_D \left[ \frac{V_m^2}{gD(S_s - 1)} \frac{\sqrt{gd(S_s - 1)}}{V_t} \right]^{-\frac{3}{2}}$$

- $K_D$  is coefficient and is set as 121
- $d_{si}$  is the corresponding particle size of 10%, 20%, 50%, 70%, 90% respectively in particle grading curve

$$d = \frac{1}{0.2 \times \sum_{i=1}^5 \frac{1}{d_{si}}}$$

## ■ Characteristic formulas

### □ Wasp Formula

- Based on Durand Formula
- This formula has considered settling loss of fine particle and frictional loss caused by coarse particle moved on the pipe

$$I = I_a + I_b$$

$$I_a = \lambda_m \rho_m \frac{v^2}{2D} \quad I_b = 82I_0 C_v \left( \frac{V^2 \sqrt{C_x}}{gD(s-1)} \right)^{-1.5} + I_0$$

- $C_x$  is the resistance coefficient of solid particle sedimentation, and  $I_0$  is the resistance grade of pure water

## ■ Characteristic formulas

### □ Jufin-Lopatin model

- Experiment condition: median particle diameter ranging from 0.25 to 11.62mm , pipe diameter ranging from 103 to 800mm.

$$I_m = I_f \cdot \left[ 1 + 2 \left( \frac{V_{\min}}{V_m} \right)^3 \right] \quad V_{\min} = 5.3 (C_{vd} \Psi^* D)^{\frac{1}{6}}$$

- $C_{vd}$  is the concentration of sand particle
- $V_m$  is the flow velocity of slurry
- $D$  is pipe diameter
- $\Psi^*$ : the constant related to diameter of sand particle

Particle Size d	$\psi^*$ Jufin & Lopatin (1966)	$\psi^*$ Jufin (1971)
0.05 - 0.10	0.0204	0.02
0.10 - 0.25	0.093	0.2
0.25 - 0.50	0.404	0.4
0.50 - 1.00	0.755	0.8
1.0 - 2.0	1.155	1.2
2.0 - 3.0	1.50	1.5
3.0 - 5.0	1.77	1.8
5 - 10	1.94	1.9
10 - 20	1.97	2.0
20 - 40	1.80	2.0
40 - 60	1.68	2.0
> 60	1.68	2.0

## ■ Characteristic formulas

### □ Wilson Model

$$\frac{I_m - I_0}{s - 1} = 0.5\mu_s \left( \frac{V_m}{V_{50}} \right)^{-M}$$

$$M = \left[ \ln \left( \frac{d_{85}}{d_{50}} \right) \right]^{-1}$$

$$V_{50} = 3.93d_{50}^{0.35} \left( \frac{s - 1}{1.65} \right)^{0.45}$$

- considered fine particles suspension and coarse particles move at the bottom of the pipeline.
- the value of M could not exceed 1.7, and it could not less than 0.25 for fine sand.  $\mu_s$  is set as 0.3



# Contents

- Introduction
- Particle motion patterns and hydraulic loss characteristics
- Resistance formula and basic theory
- **Practical Calculation and Formula Evaluation**

## ■ Practical condition

- CSD Tianniu working in long-distance reclamation of medium sand.
- diameter of discharge pipe : 800mm
- length of standard pipeline:8100m
- undisturbed soil density :1.9
- slurry concentration :18%-20%
- flow velocity :3.6-3.8m/s
- discharge pressure :16.5 bars
- grading curve of soil particle

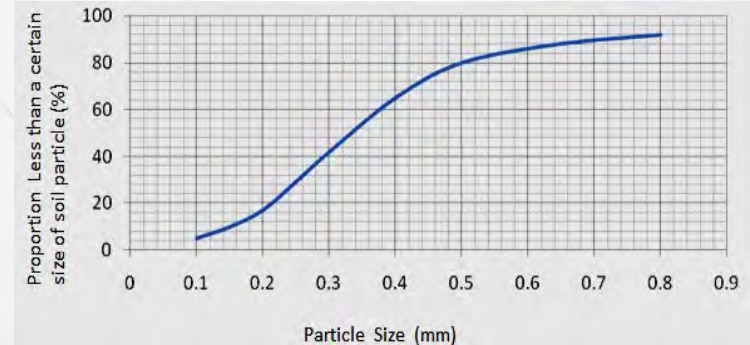

## ■ Calculation condition

- concentration of undisturbed soil:19%
- Density:1.187
- concentration of soil particle 11%
- flow velocity 3.7m/s
- **average particle size** calculated by method of weighted mean:0.277mm
- **discharge pressure** is 16.5 bars

the actual hydraulic loss coefficient is  
 $\lambda_m = 0.0238$

## ■ Calculation result

- The results of loss coefficient calculated by different formulas:

Formula	$\lambda_m$
Durand	0.0380
Wasp	0.0288
Jufin-Lopatin	0.0263
Wilson	0.0226

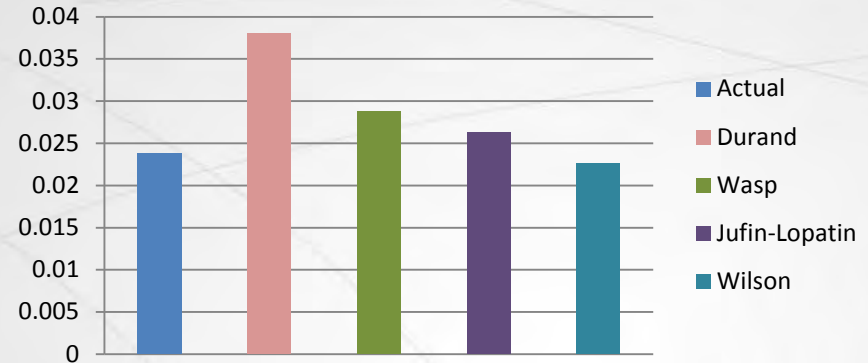

- Using above formulas to calculate the total discharge pressure with particle concentration of 5%, 11% and 15% separately and compare with the actual measured values

## ■ Calculation result

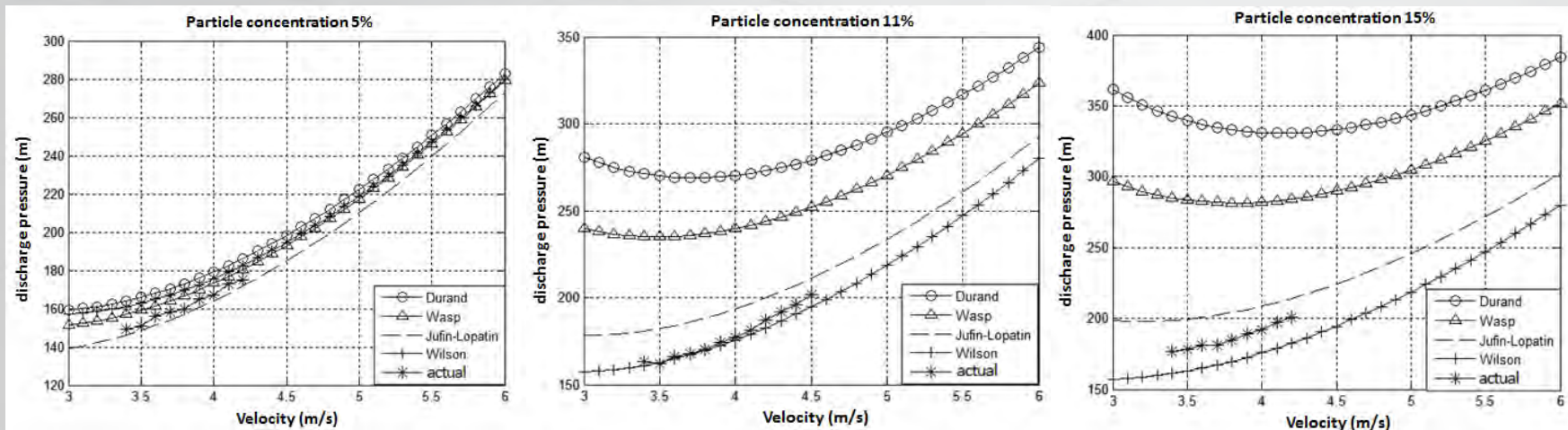

- Durand Formula and Wasp Formula are based on gravitational theory
- Hydraulic loss calculated by Durand Formula and Wasp Formula is significantly larger than the actual values when the flow velocity is low and the concentration is high.
- With flow velocity increasing, the results calculated by Durand Formula and Wasp Formula get closer to the actual values.

## ■ Calculation result

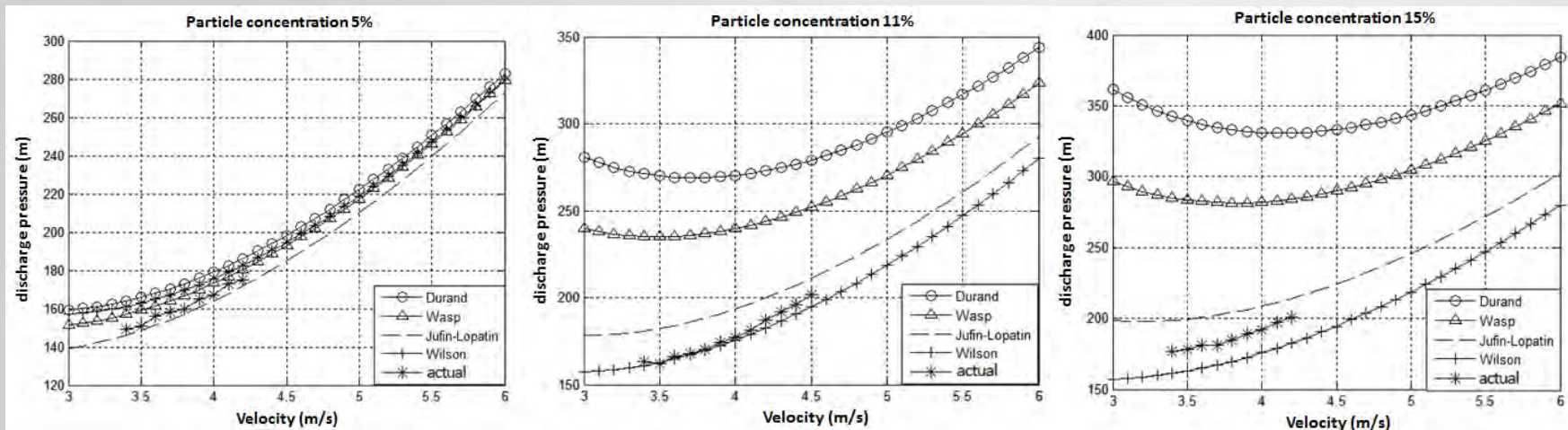

- Jufin-Lopatini Model and Wilson Model have considered the influence of uneven particle on pipe resistance
- Actual values always between results calculated by Jufin-Lopatini Model and Wilson Model and are agreed well with results calculated by the two models.
- Wilson model has a high sensibility for the value of characteristic particle size in particle size distribution curve



中国交建  
CHINA COMMUNICATIONS CONSTRUCTION

Thank you for attentions!